

# hayneedle



Item Name:  
Del Rey Double Chaise Lounge With Canopy

SKU: TTLC280-1



**For assistance with assembly, please contact customer service  
1-888-880-4884**

# PRE-ASSEMBLY PREPARATION













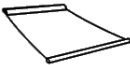







DO NOT LET CHILDREN PLAY IN OR AROUND THE UNIT DUE TO THE POSSIBLE RISK OF FINGER ENTRAPMENT

- Please read through this instruction before beginning assembly.
- Two adults assembly is recommended.
- Clear out the space for assembly and lay out all parts base on Parts List, extra room will allow you to easily determine if all the pieces are present.
- Save all packing materials until assembly is complete to avoid accidentally discarding smaller parts or hardware.
- Keep small parts and pieces away from children until fully assembly.
- Please check for any loose screws and tighten them before you use.

## Important to Note:

Do not fully tighten bolts until entire piece is assembled.

Once assembled you will tighten all the bolts to fully secure item.

1. Shelf	1PCS		10. Bolt (Long M8*105L)	4PCS	
2. Block Cross tube(1)	1PCS		11. Bolt (Short M8*65L)	2PCS	
3. Block Cross tube(2)	1PCS		12. Nut (M8)	6PCS	
4. Seat tube	2PCS		13. Metal washer	12PCS	
5. Canopy support tube	2PCS		14. Plastic bolt cap (M8)	6PCS	
6. Top cross beam	1PCS		15. Plastic nut cap (M8)	6PCS	
7. Canopy frame straight bar	2PCS		16. Canopy cover	1PCS	
8. Canopy frame "U"bar	2PCS		17. Hex wrench	2PCS	
9. Knob	2PCS		18. Touch-up paint bottle	1PCS	

# STEP-BY-STEP ASSEMBLY:

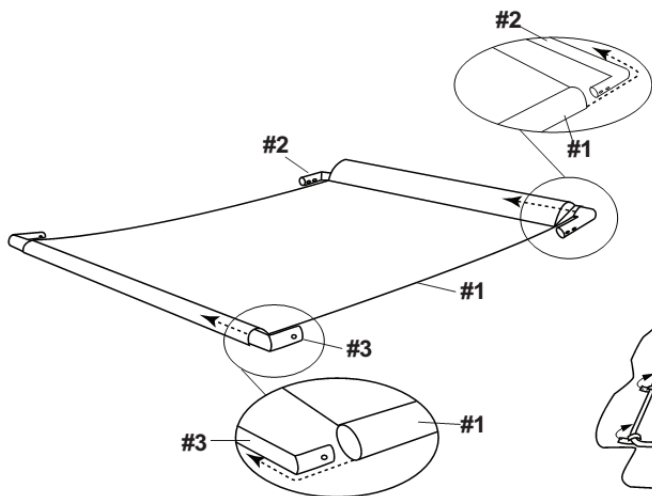

STEP. 1

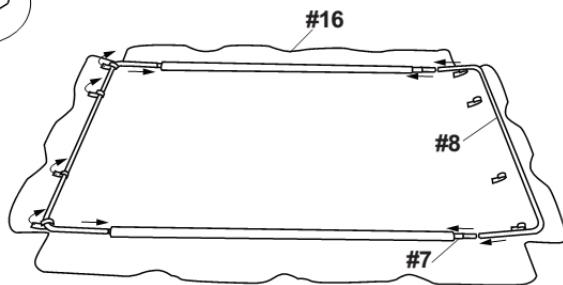

STEP. 3

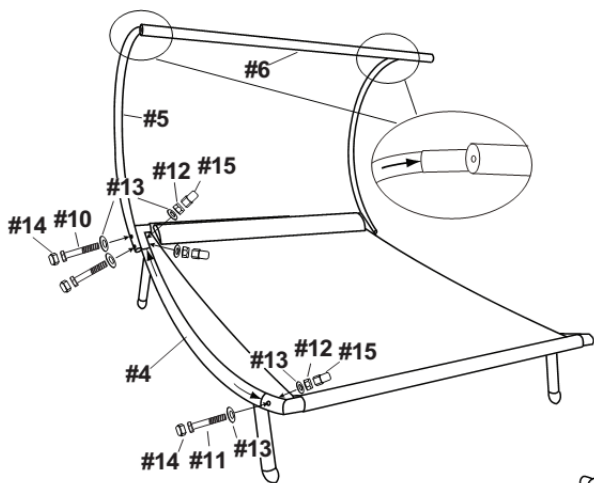

STEP. 2

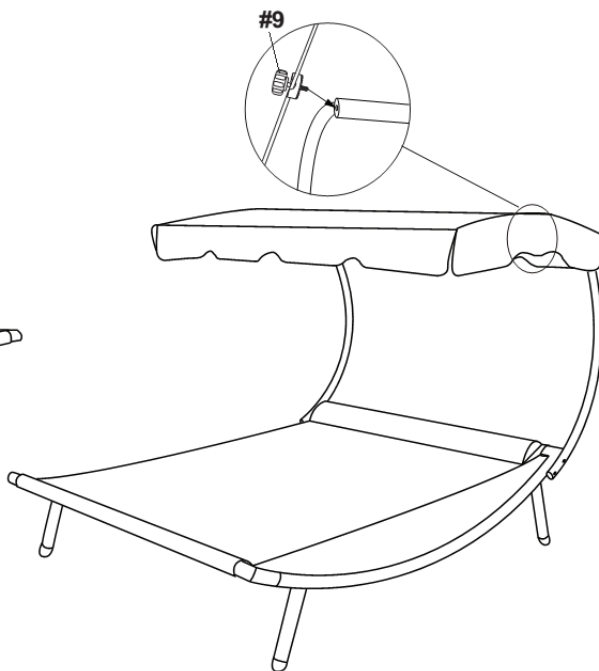

STEP. 4