

ITEM NAME:[HOLLOWCORE L-SHAPED DESK]
SKU:[STIP007-1 STIP007-2]

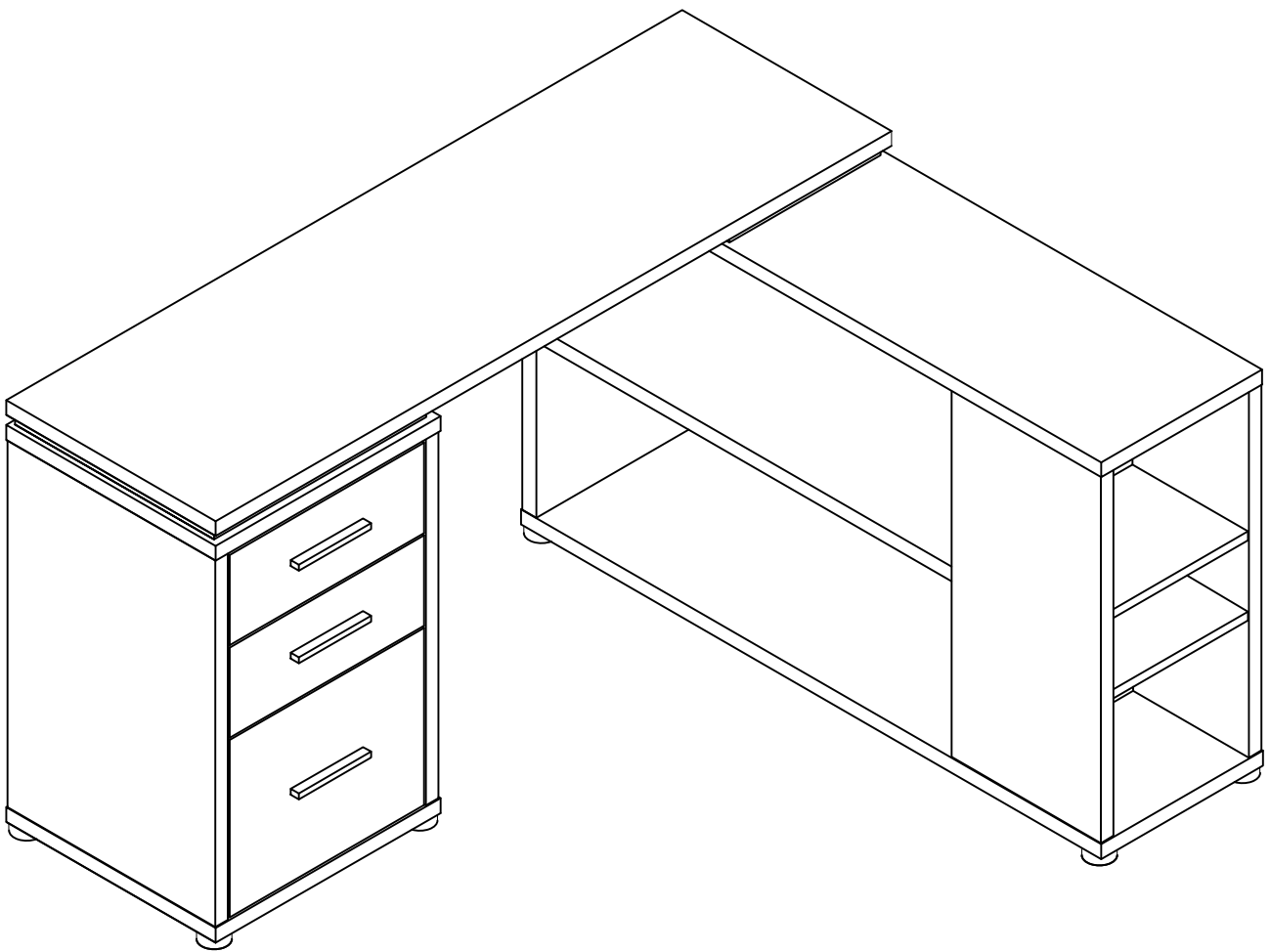

For assistance with assembly, please contact
Hayneedle Customer Care Center
1-888-880-4884

Step 12:

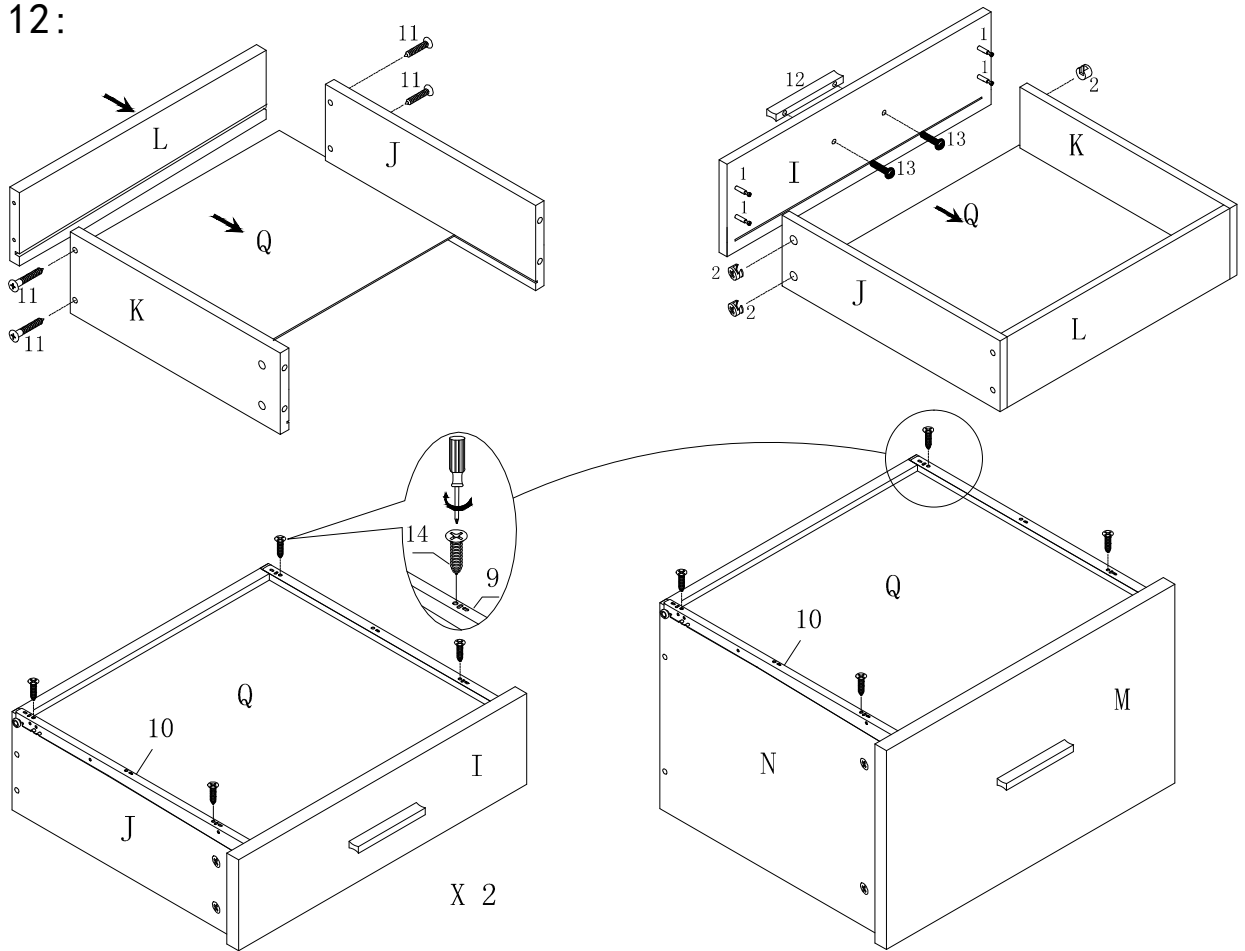

Step 13:

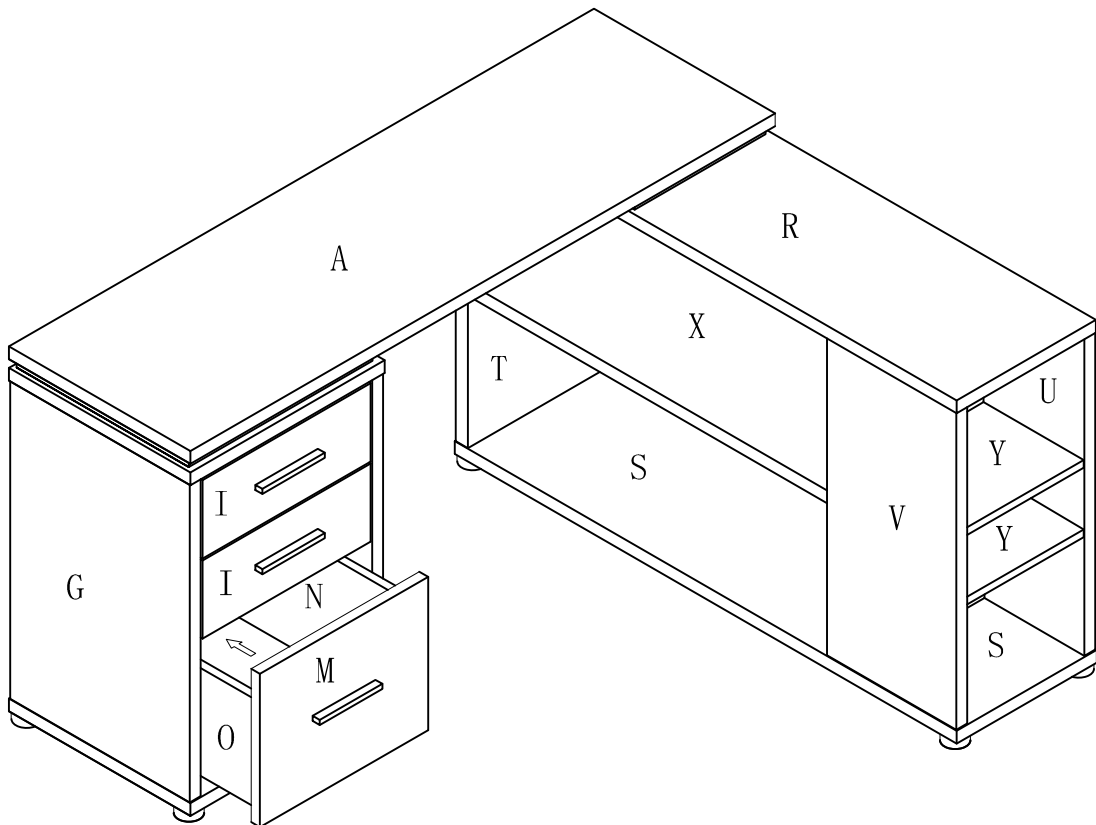

Thanks for your purchase

PRE-ASSEMBLY PREPARATION:



THIS PACKAGE MAY CONTAIN SMALL ITEMS WHICH SHOULD BE KEPT AWAY FROM CHILDREN

.Please check that all parts and hardware are included before beginning assembly.

.Save all packing materials until assembly is complete to avoid accidentally discarding smaller parts or hardware.





.Read through the preparation and assembly instructions in full before beginning assembly.





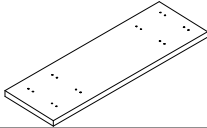

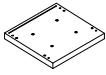
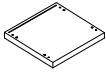
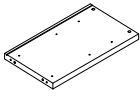
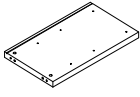
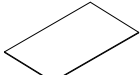
.Please use **CAUTION AND CARE WHEN LIFTING** the product to avoid personal injury and (or) damage to the product.

.The following additional tools are required for assembly: Screwdriver

.For ease of assembly, two adults are recommended.





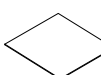
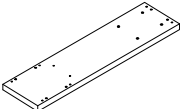

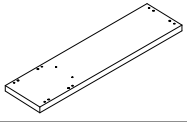
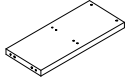
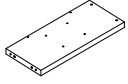
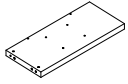
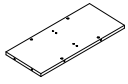
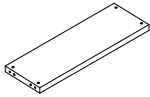
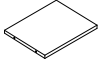

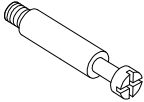
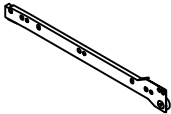

PANEL AND FITTINGS IDENTIFICATION:

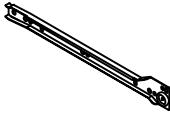
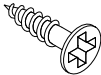
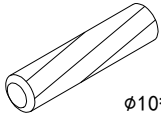
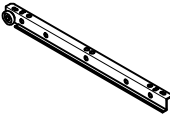
A		1PCS
B		1PCS
C		1PCS
D		1PCS
E		1PCS
F		1PCS
G		1PCS
H		1PCS
I		2PCS

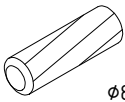
J		2PCS
K		2PCS
L		2PCS
M		1PCS
N		1PCS
O		1PCS
P		1PCS
Q		3PCS
R		1PCS

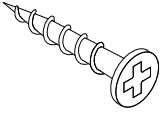
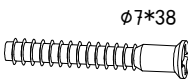
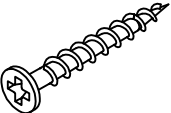
S		1PCS
T		1PCS
U		1PCS
V		1PCS
W		1PCS
X		1PCS
Y		2PCS

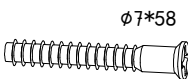
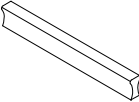
HARDWARE LIST:

1		30PCS	7		3PCS	13		6PCS
2		30PCS	8		3PCS	14		24PCS
3	 ø10*40	20PCS	9		3PCS	15		8PCS
4	 ø8*30	16PCS	10		3PCS	16		8PCS
5	 ø7*38	8PCS	11		12PCS	17		10PCS
6	 ø7*58	18PCS	12		3PCS	18		4PCS

TOOLS REQUIRED:

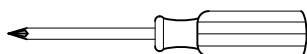

STRUCTURAL DIAGRAM:

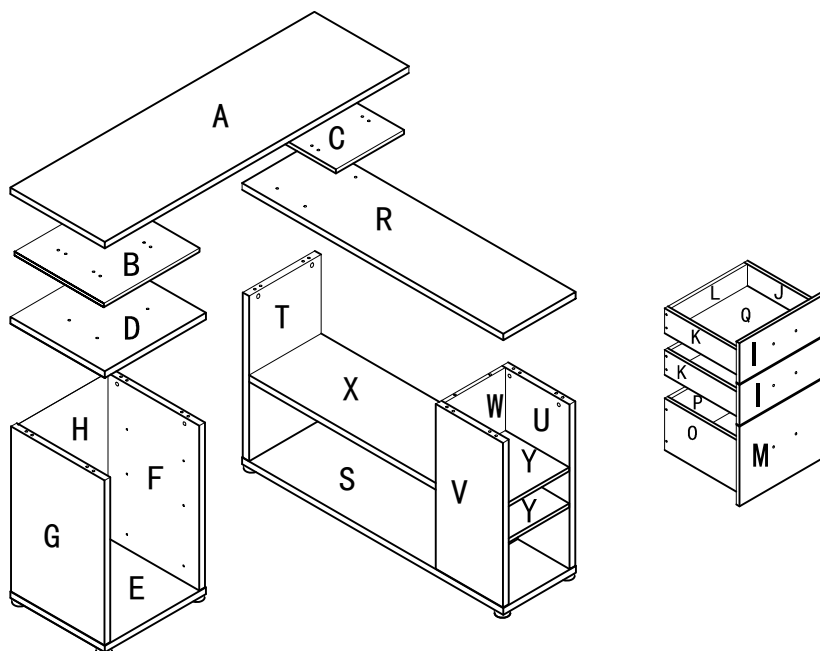

CAMLOCK INSTRUCTION

This product is assembled with a cam lock set

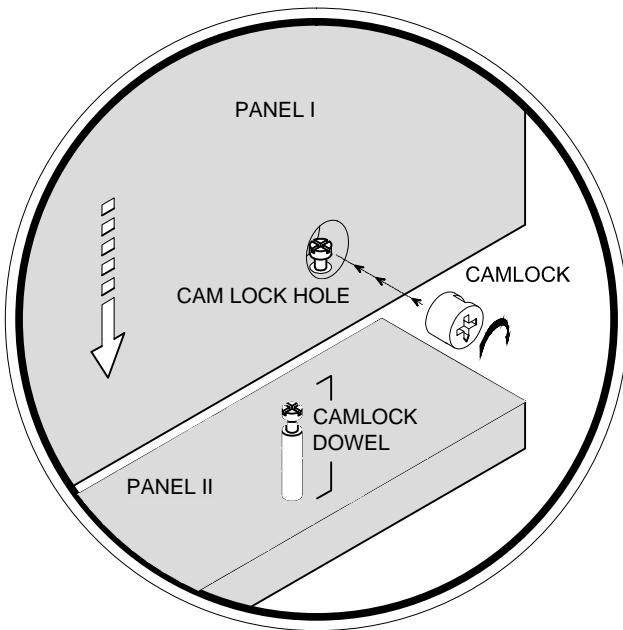

STEP 1: Insert Cam Lock into the cam lock hold of Panel I. Cam lock arrow should be pointing towards the cam lock dowel insertion hole.

STEP 2: Insert the cam lock dowel into Panel II.

STEP 3: Connect Panel I and Panel II by inserting the cam lock dowel through the hole to which the cam lock arrow is pointing.

STEP 4: Press panel I and Panel II together.

STEP 5: Lock panels together by turning cam lock clockwise using a screwdriver. The cam lock and dowel should make a click sound, indicating they are locked together.

STEP-BY-STEP ASSEMBLY:

STEP 1:

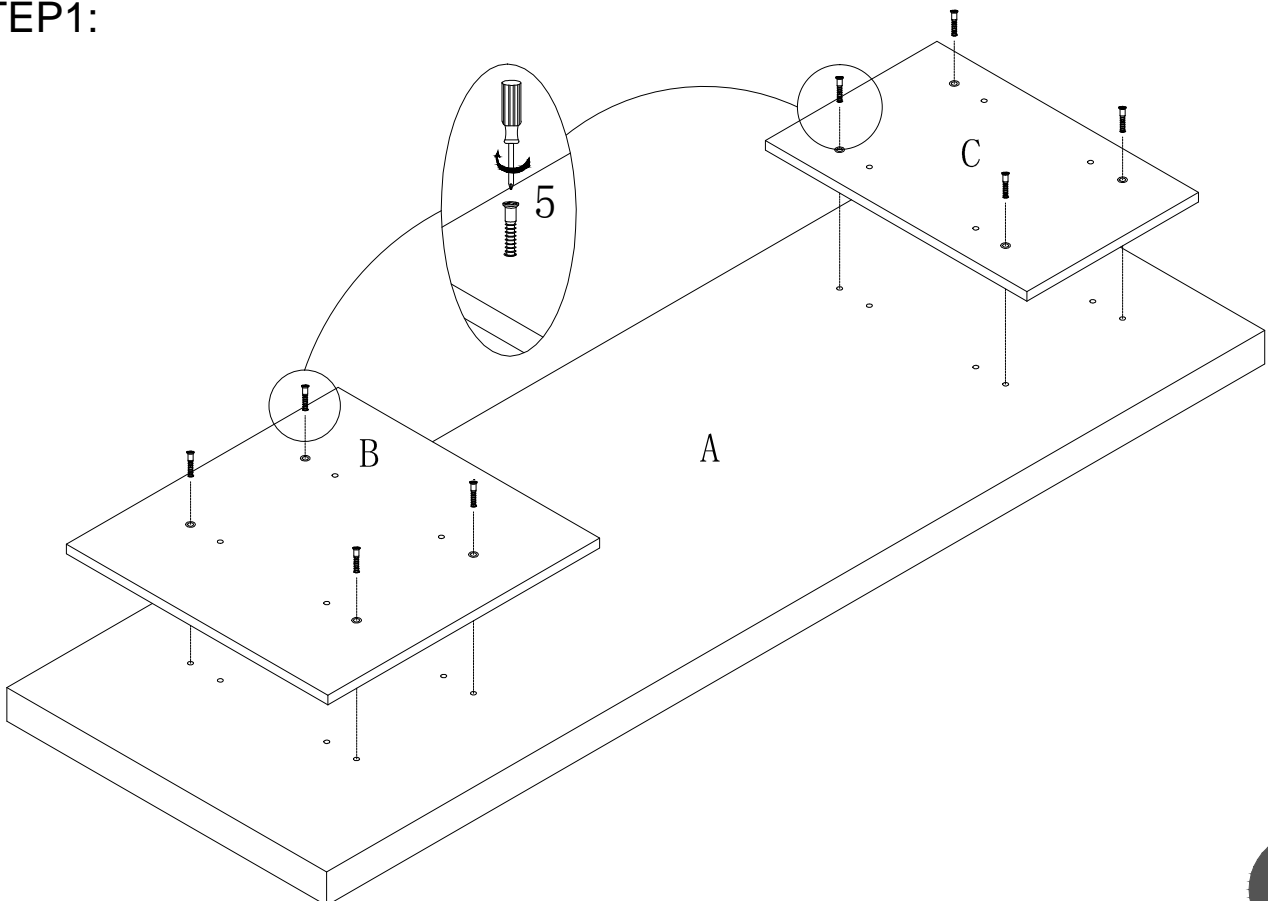

Step 2:

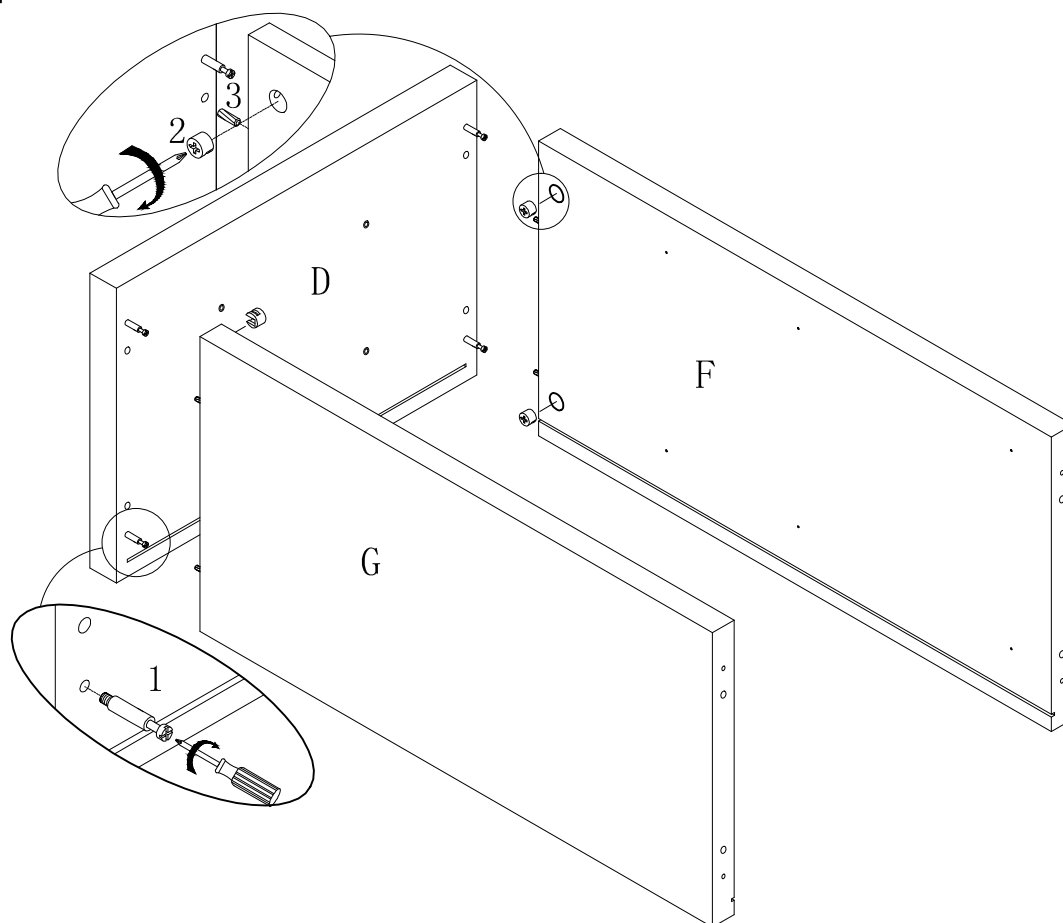

Step 3:

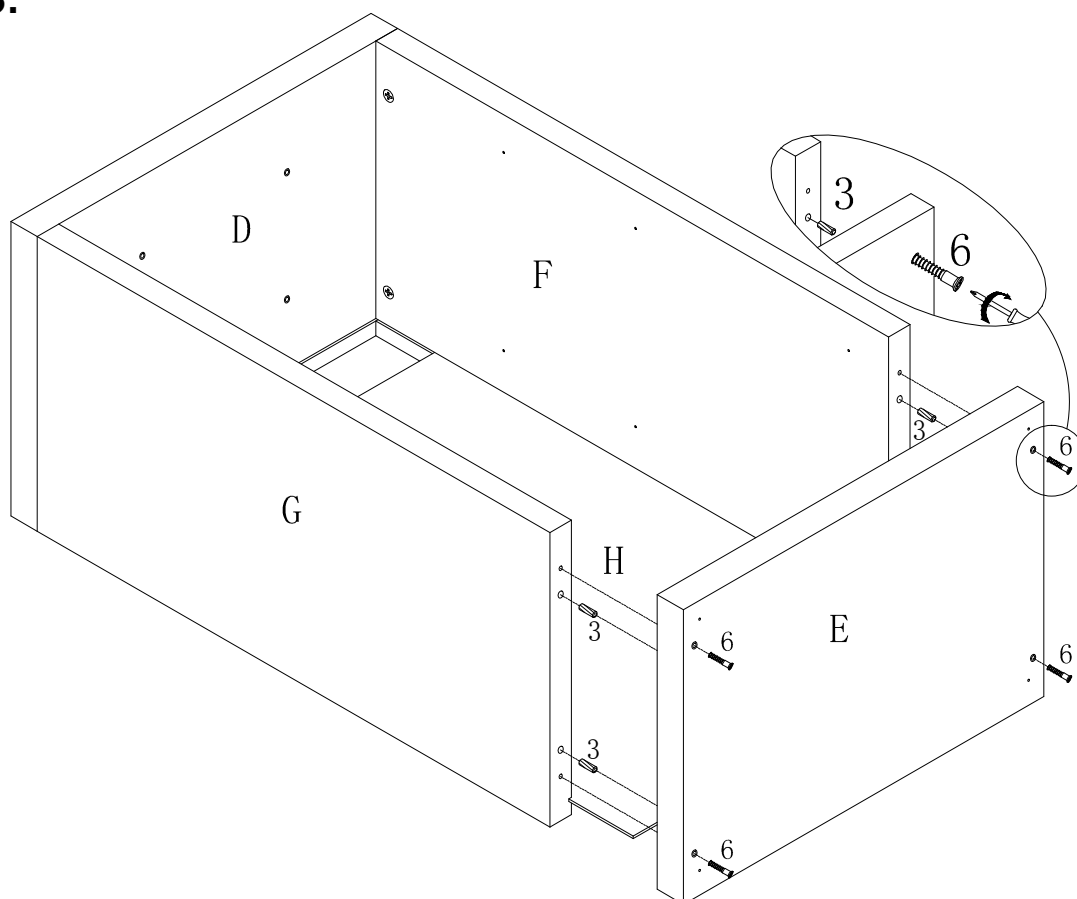

Step 4:

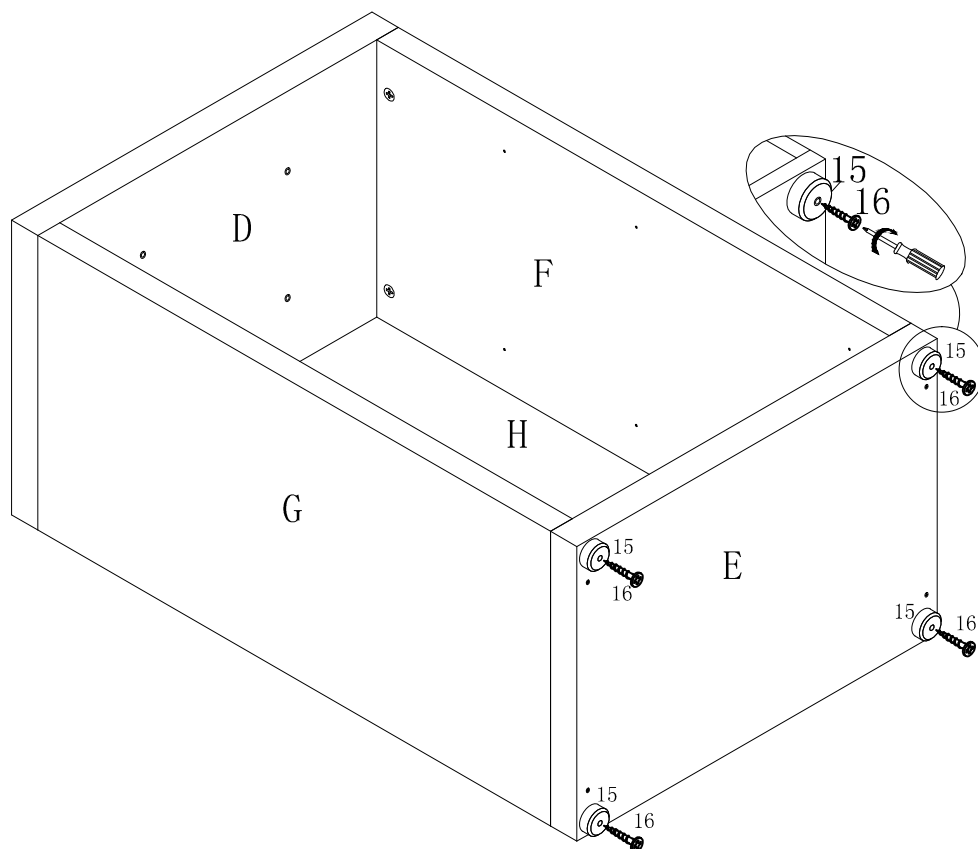

Step 5:

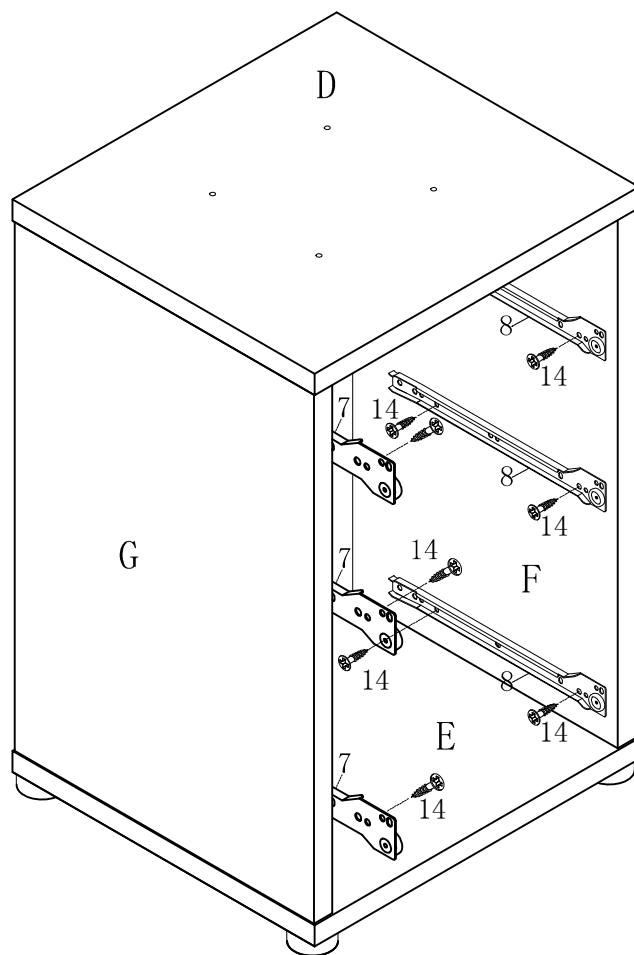

Step 6:

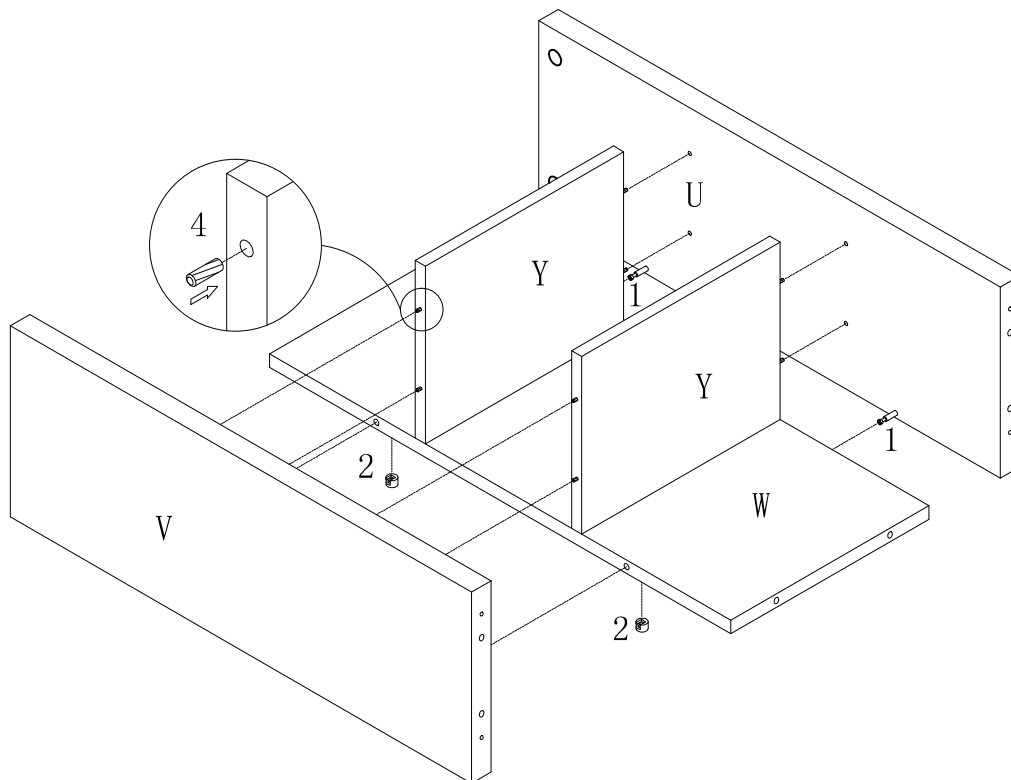

Step 7:

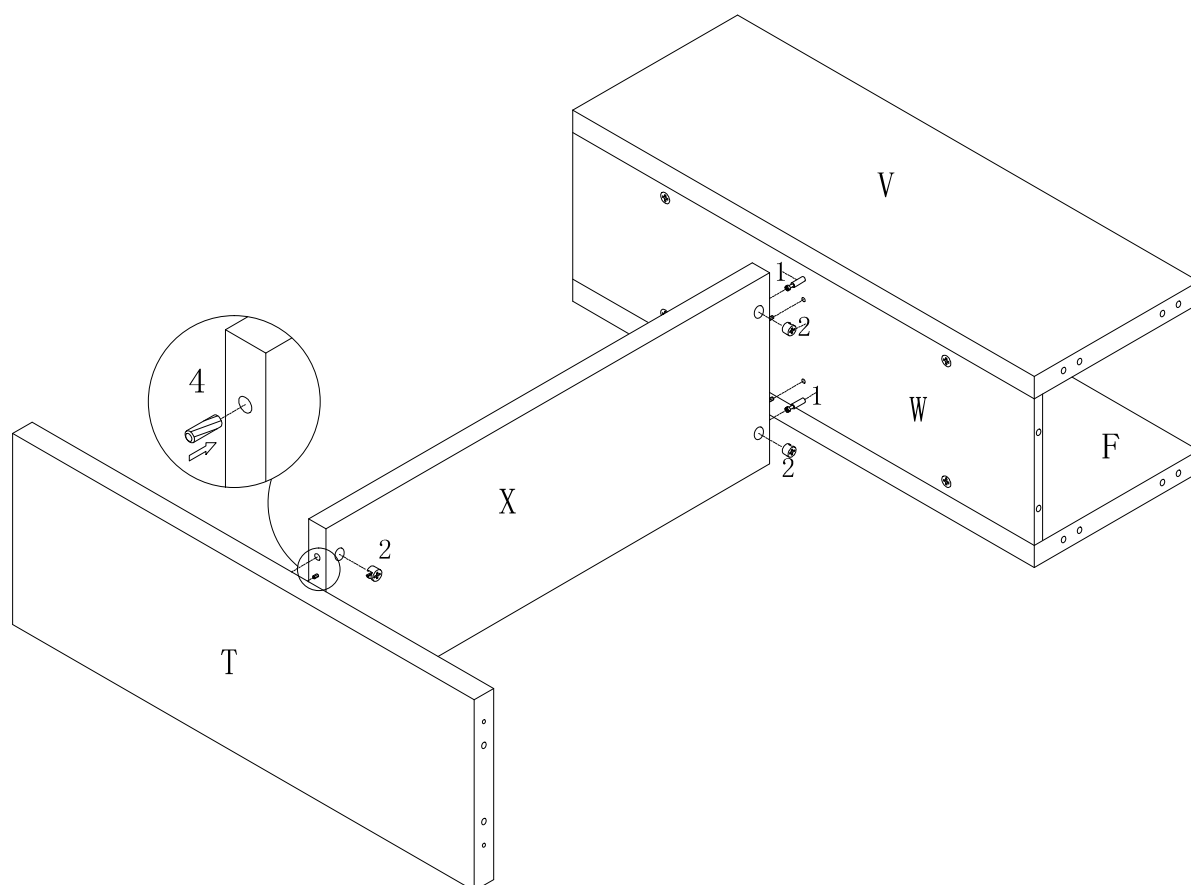

Step 8:

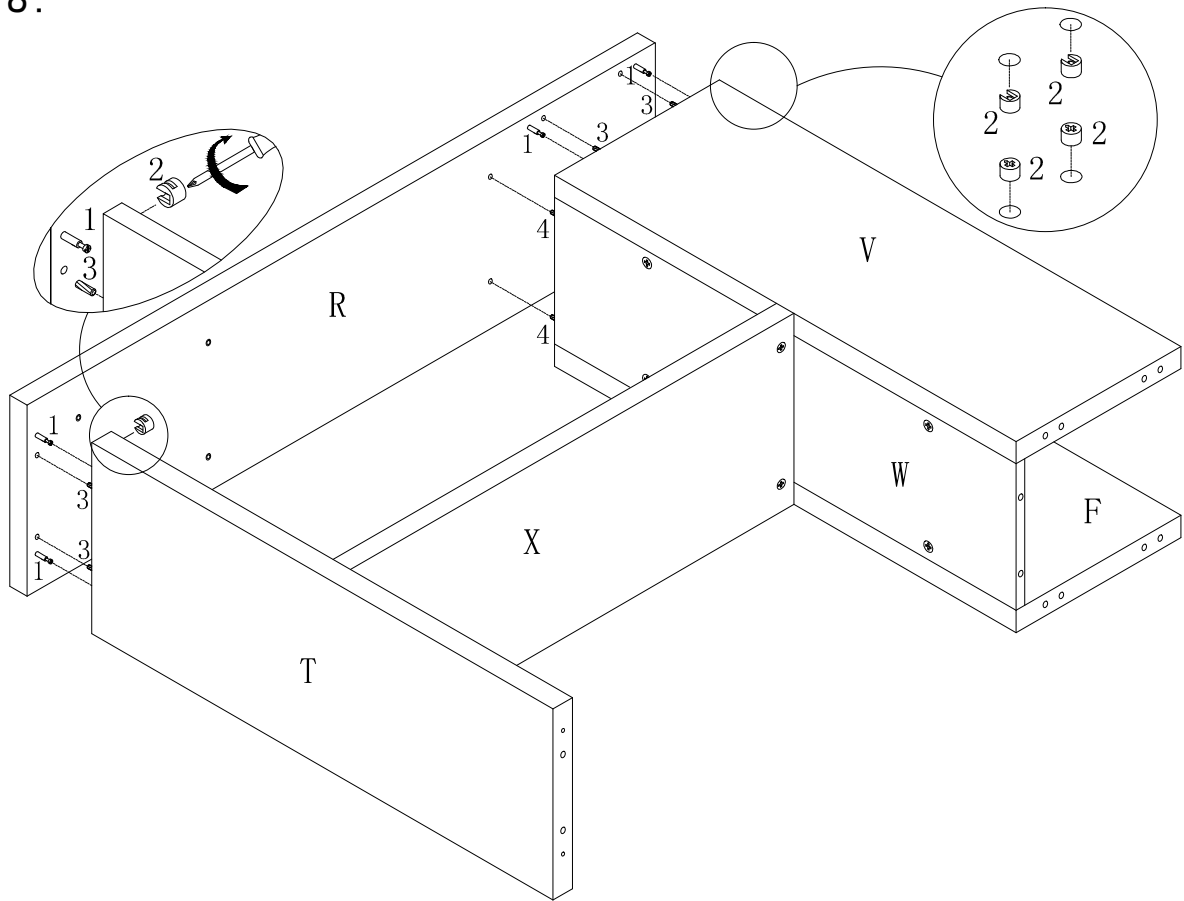

Step 9:

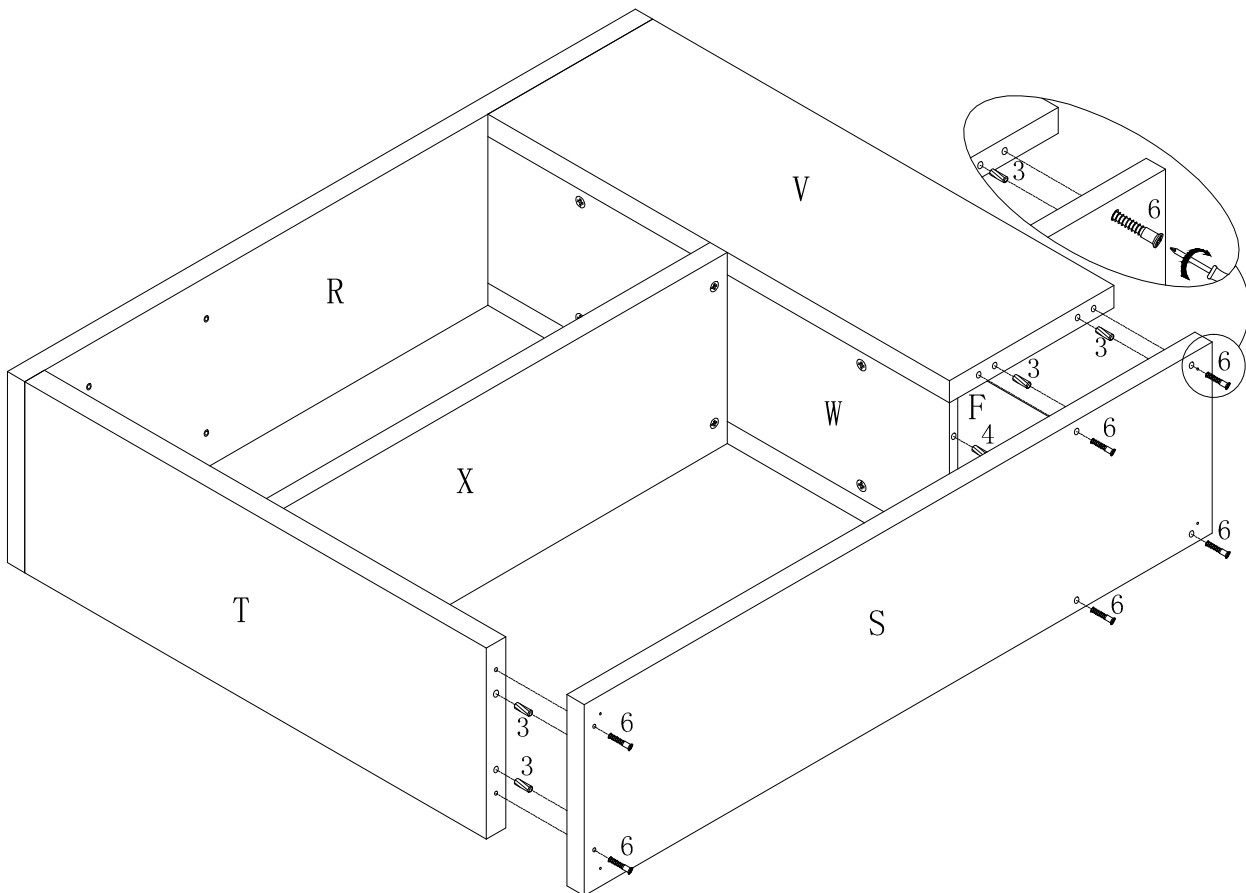

Step 10:

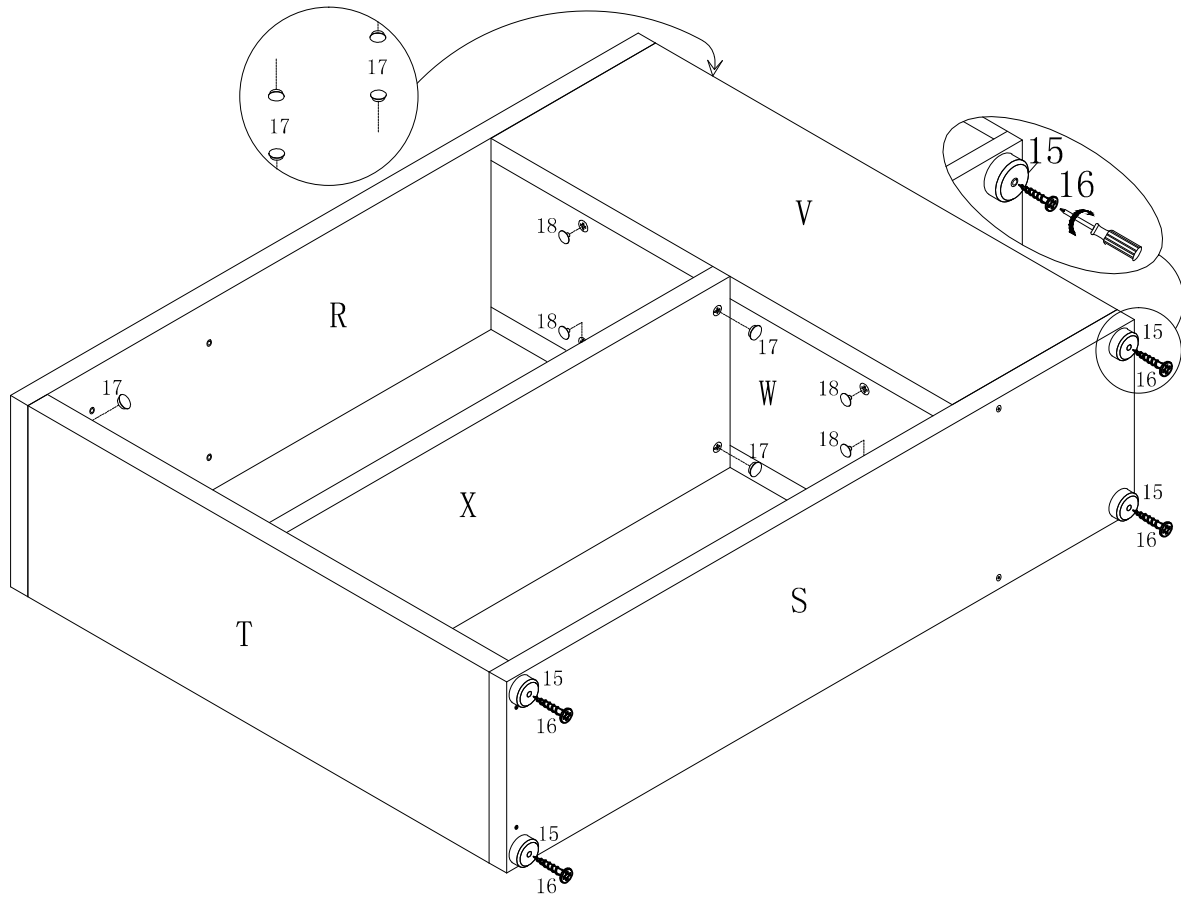

Step 11:

