

FASHION BED GROUP.

A *Lasalle & Harper* COMPANY

6755 W. 65th Street-Bedford Park, IL 60638

Parts List For Lasalle/Harper SNAP Bed

BED CARTON

- (1) HEADBOARD PANEL-1
- (2) EXTENSION LEG-2
- (3) PILLOW BAR-1
- (4) SIDE RAILS-2
- (5) FOOTBOARD PANEL-1
- (6) CROSS RAILS-4
- (7) SUPPORT LEGS-6

HARDWARE BAG #398002

- (8) 1/4-20 X 2 1/4" FLAT ALLEN HEAD SCREW-4
- (9) 4MM ALLEN WRENCH-1

1

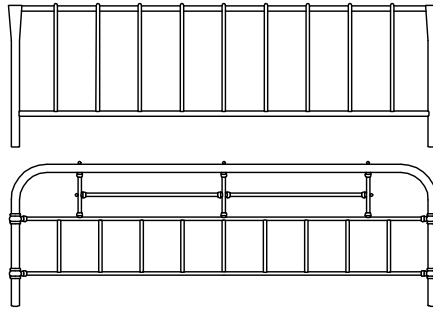

2

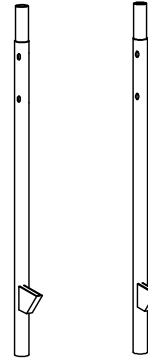

3

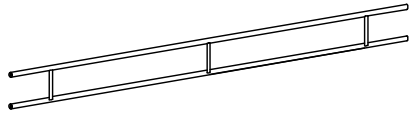

5

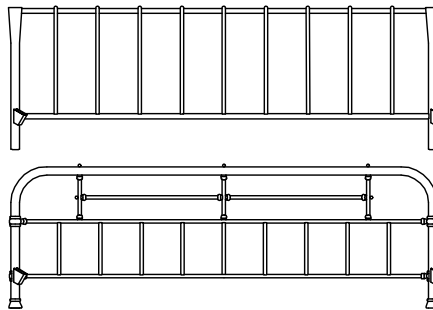

6

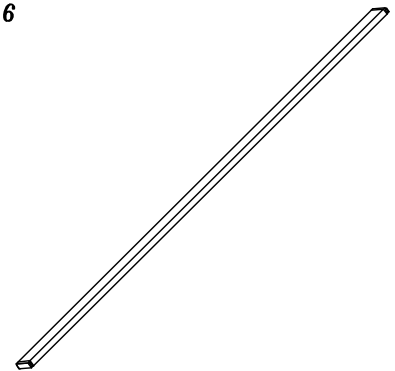

4

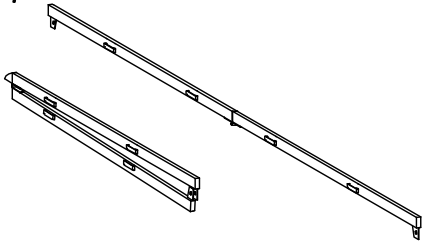

7

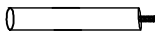

8



9



SAVE ALL PACKAGING MATERIALS UNTIL PRODUCT IS FULLY ASSEMBLED. HARDWARE AND SMALL PIECES MAY NOT BE SEEN AND COULD BE ACCIDENTALLY DISCARDED WITH PACKAGING MATERIALS.

Instruction Sheet

Step 1- Assembly of Headboard Panel .

- Align pilot holes on extension legs (2) with threaded inserts on Pillow bar (3) rails make sure welded pocket facing same direction. SEE FIGURE 1
- Secure pillow bar (3) with screw (8). Use Allen wrench (9).
DO NOT TIGHTEN SCREWS COMPLETELY
- Now Carefully insert headboard panel (1) over extension legs (2). SEE FIGURE 2
- Now tighten screws (8) completely. Use Allen wrench (9).

FIGURE 1

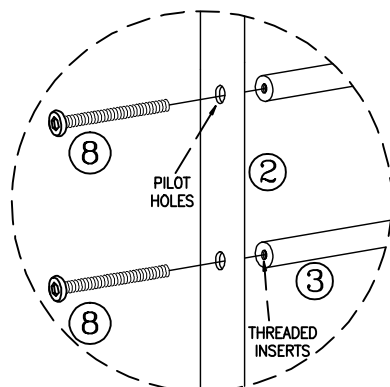

FIGURE 2

