

# hayneedle

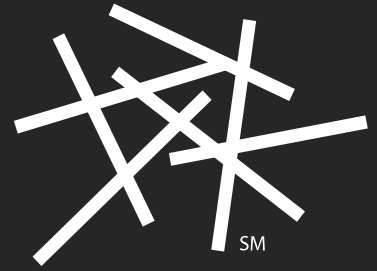

ITEM NAME: Belham Living Mid Century Modern Tufted Upholstered Bench

SKU: REDU082-1

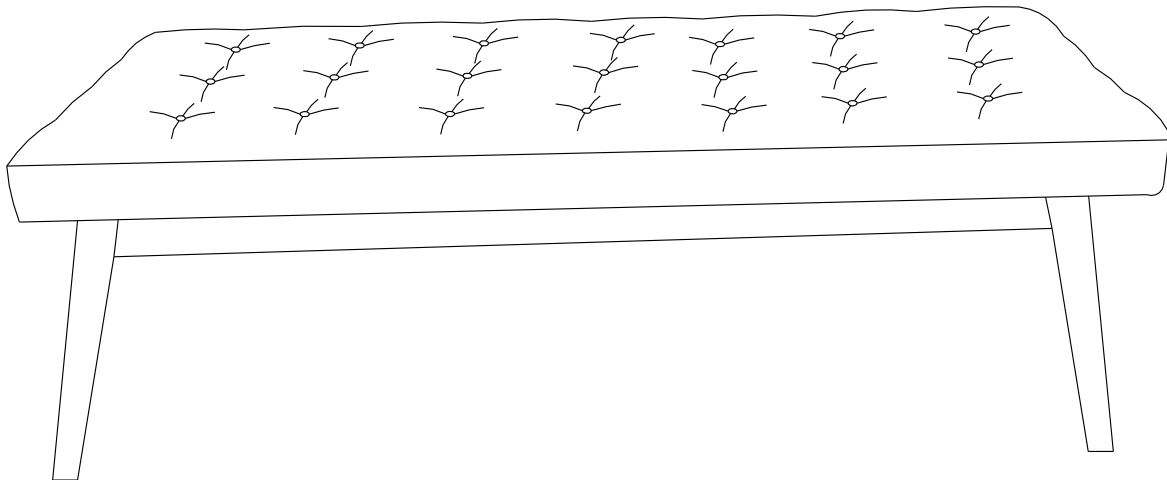

For assistance with assembly, please contact customer service  
1-888-880-4884

## PRE-ASSEMBLY PREPARATION:



**DO NOT LET CHILDREN PLAY IN OR AROUND THE UNIT DUE TO THE POSSIBLE RISK OF FINGER ENTRAPMENT**

- Please read through this instructions before beginning assembly.
- Two adults are recommend for assembly.
- Clear out the space for assembly and lay out all parts based on Parts List. Extra room will allow you to easily determine if all the pieces are present.
- Save all packing materials until assembly is complete to avoid accidentally discarding smaller parts or hardware.
- Keep small parts and pieces away from children until fully assembled.
- Please check for any loose screws and tighten them before you use.

## PANEL AND FITTINGS IDENTIFICATION:

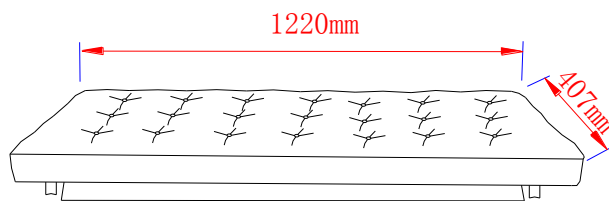

Face Frame (1) Qty:1

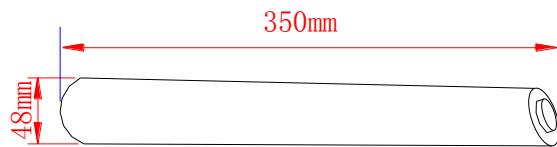

Leg (2) Qty:4

## HARDWARE LIST: Scaled to Actual Size

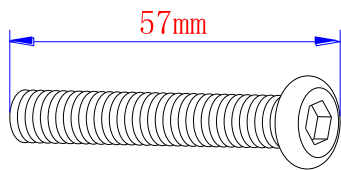

Bolt (A) Qty:8

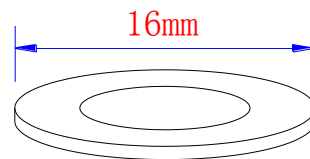

Flat Washer (C) Qty:8

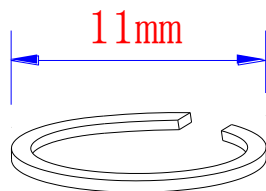

Spring Washer (B) Qty:8

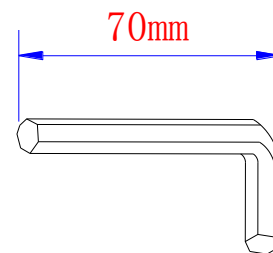

Allen Key (D) Qty:1

## STEP-BY-STEP ASSEMBLY:

Please follow directions closely as all pieces are marked specifically and must be assembled as shown

- 1** STEP 1: Lay the face frame upside down, cut open fixed bandages, and take out the bench legs. Lay the face frame (1) upside down on the floor. Secure the legs (2) to face frame with the flat washer (A), spring washer (B), and bolt (C) by using allen key (D) clockwise. Level the bench and tighten all bolts securely.

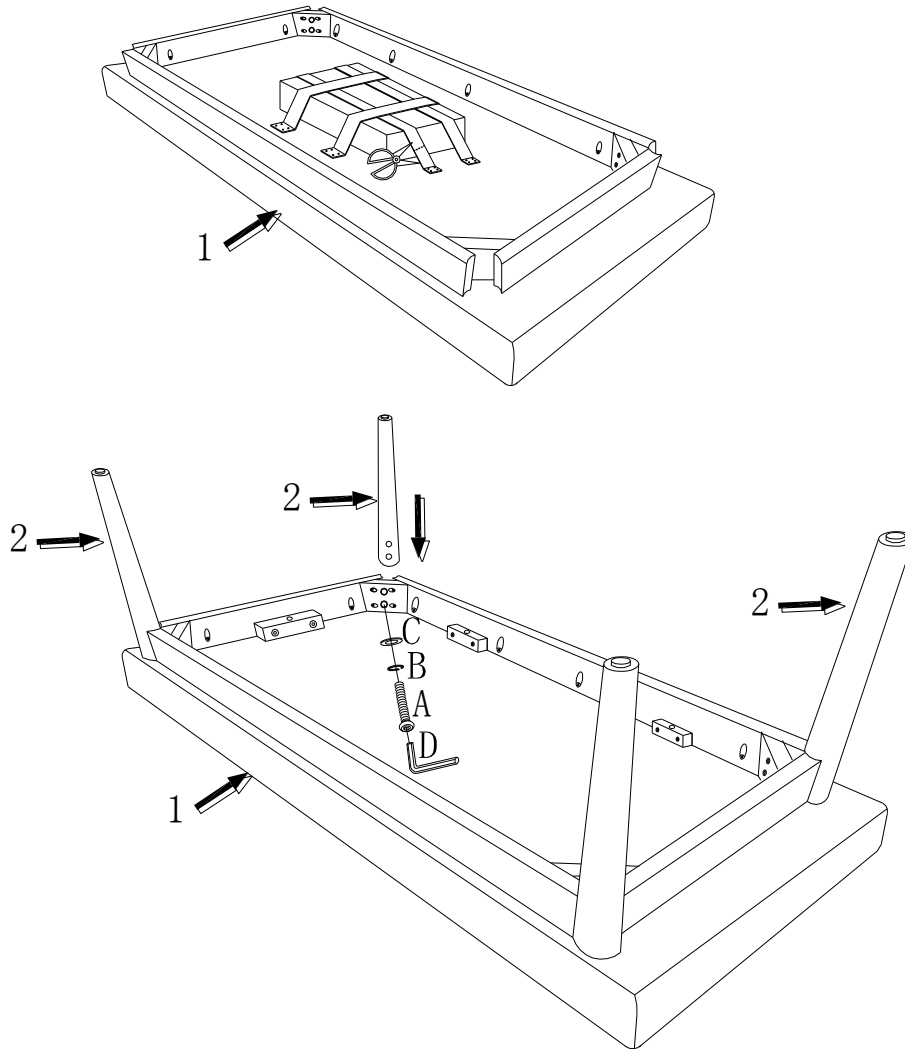

## MAINTENANCE AND CARE TIPS

- Check and re-tighten screws/bolts after the product has been used for a period of time.
- Dust with a soft cloth moistened with a polish as the polish will help eliminate the scratching that occurs with dry dusting.
- Soap and water are not advisable for wood surfaces.
- It is best to keep your furniture in a climate controlled environment. Extreme temperature and humidity changes can cause warping, shrinking, and spitting of wood. It is advised to keep furniture away from direct sunlight as it may damage the finish.
- Do not stand on the unit as it with a soft surface to load the weight of body.