

hayneedle

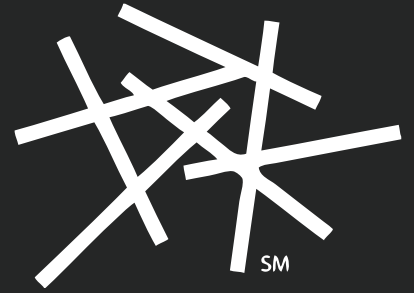

ITEM NAME: Belham Living Carter Mid Century Modern Side Table
SKU: REDU036-1

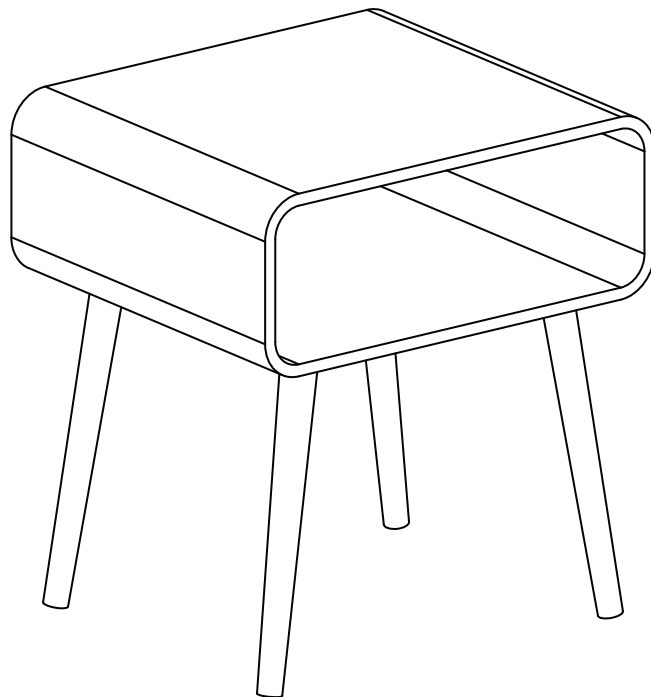

For assistance with assembly, please contact customer service
1-888-880-4884

PRE-ASSEMBLY PREPARATION:





DO NOT LET CHILDREN PLAY IN OR AROUND THE UNIT DUE TO THE POSSIBLE RISK OF FINGER ENTRAPMENT

- Please read through these instructions before beginning assembly.
- Two adults are recommended for assembly.
- Clear out the space for assembly and lay out all parts based on Parts List, extra room will allow you to easily determine if all the pieces are present.
- Save all packing materials until assembly is complete to avoid accidentally discarding smaller parts or hardware.
- Keep small parts and pieces away from children until fully assembled.
- Please check for any loose screws and tighten them before you use.

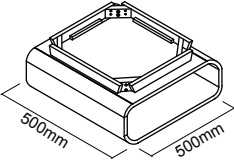
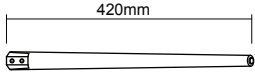
PANEL AND FITTINGS IDENTIFICATION:

 <p>Cabinet (1) Qty:1</p>	 <p>Leg (2) Qty:4</p>	
---	--	--

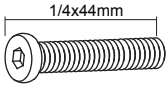
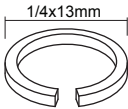
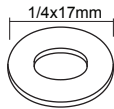
HARDWARE LIST:

 <p>Bolt (A) Qty:8</p>	 <p>Spring Washer (B) Qty:8</p>	 <p>Flat Washer (C) Qty:8</p>
 <p>Allen Key (D) Qty:1</p>		

STEP-BY-STEP ASSEMBLY:

- 1 Assemble the Legs (02) to the Cabinet (01) using Bolts (A) with Spring Washers (B) and Flat Washers (C), tighten with Allen Key (D).

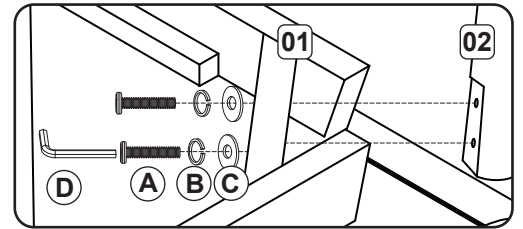
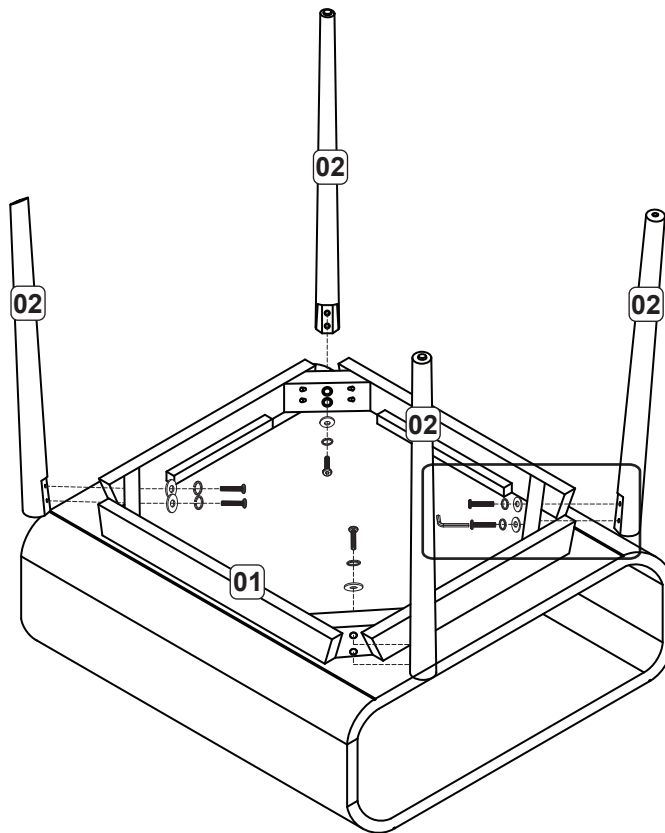

MAINTENANCE AND CARE TIPS FOR WOOD FURNITURE:

Wooden furniture caring tips:

- Always dust, wipe and clean in the direction of the wood grains.
- Check and re-tighten screws/blots after the product has been used for a period of time.
- Heat creates chemical changes in the furniture finish. As a result, whitish spots may appear.
- Dust with a soft cloth moistened with a polish, as the polish will help eliminate the scratching that occurs with dry dusting.
- Soap and water are not advisable for wood surfaces.
- Do not allow rubber or vinyl material to lay on the furniture.
- Always use coasters under beverage glasses and flowerpots.
- Liquid spills should be removed immediately. Using a soft clean cloth, blot the spill gently. Avoid rubbing.
- It is best to keep your furniture in a climate controlled environment. Extreme temperature and humidity changes can cause warping, shrinking and spitting of wood. It is advised to keep furniture away from direct sunlight as it may damage the finish.