

# 1

## ASSEMBLY INSTRUCTION MODEL NO. 73022-40

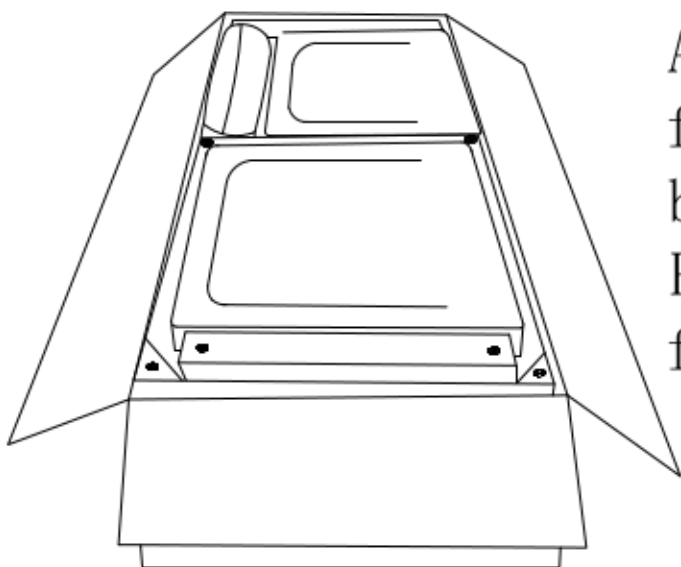

After removing all pieces from the box, please peel back the dust covers on Part M, Part N, & Part O to find Part I, Part K, & Part J

A Legs 8PCS



B Spanner  
1pcs

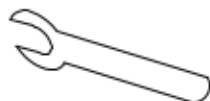

C Screw  
lock 10pcs

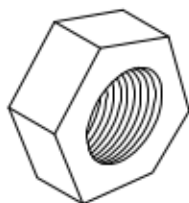

D Washer  
14pcs



E: Spanner  
1 pcs



F: Metal  
legs 2 pcs

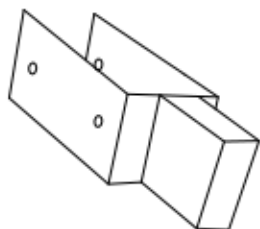

G Screw 6  
PCS



H Screw 4  
PCS



I:3PCS

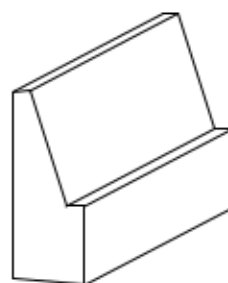

J:3PCS

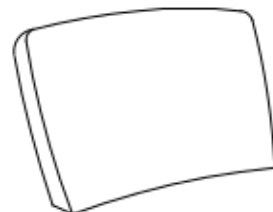

K:1 PCS

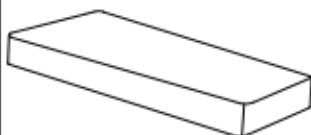

L:2 PCS

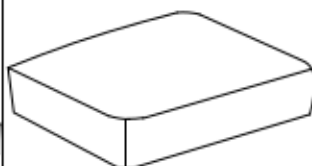

M:1 PCS

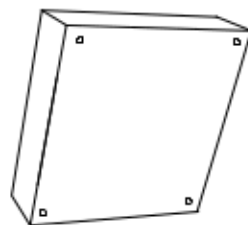

N:1 PCS

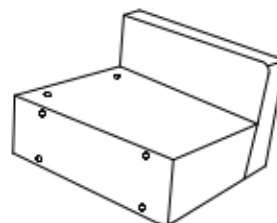

O:1 PCS

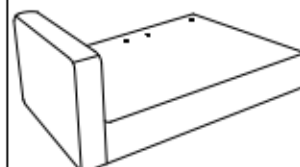

Hidden Compartment

Hidden Compartment

Hidden Compartment

# 2

## ASSEMBLY INSTRUCTION

MODEL NO. 73022-40

### STEP 1

Part 0  
Peel Back dust covers  
to reveal cushions

# 0

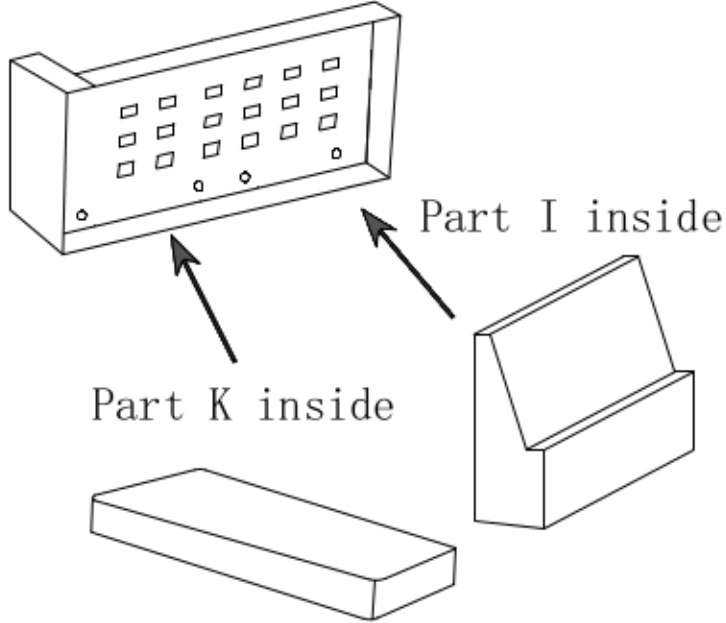

### STEP 2

Part N

# N

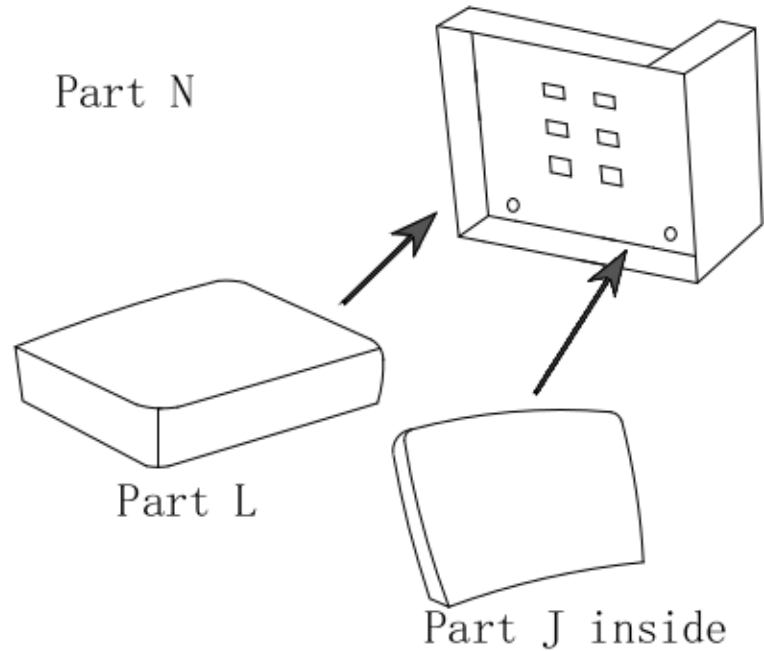





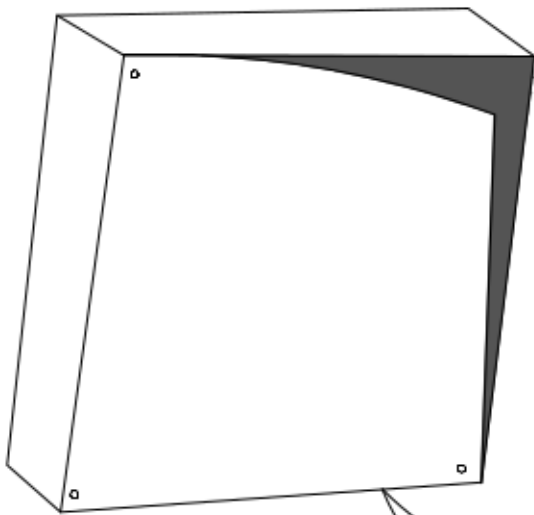



### STEP 3

# M

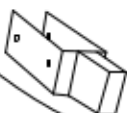

Part M  
Peel Back dust covers  
to reveal missing cushions

A Legs 8PCS 	B Spanner 1pcs 	C Screw lock 10pcs 	D Washer 14pcs 	E: Spanner 1pcs 
F: Metal legs 2 pcs 	G Screw 6 PCS 	H Screw 4 PCS 	J 1pcs 	

3

# ASSEMBLY INSTRUCTION

MODEL NO. 73022-40

STEP 4

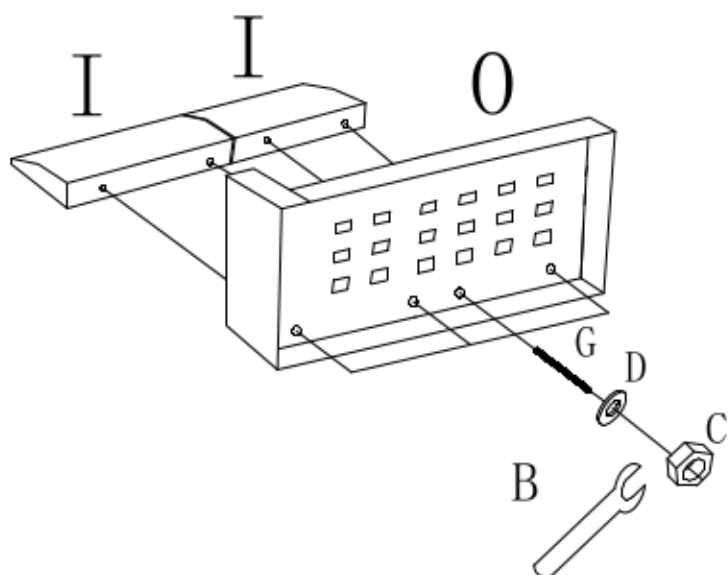

STEP 5

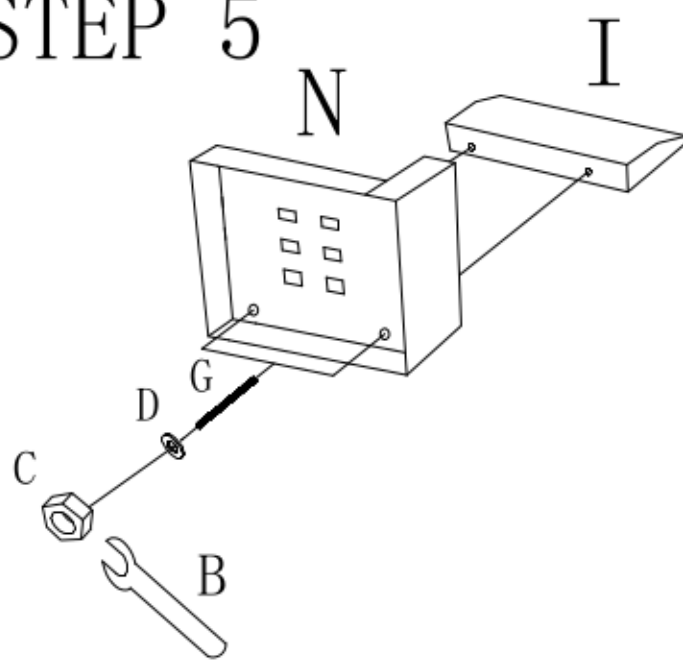

STEP 6

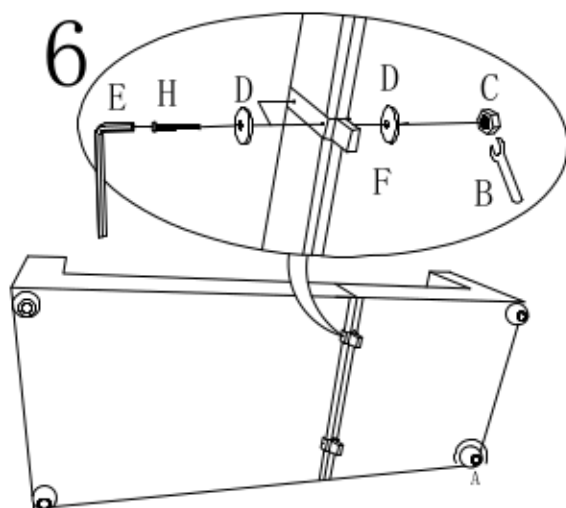

STEP 7

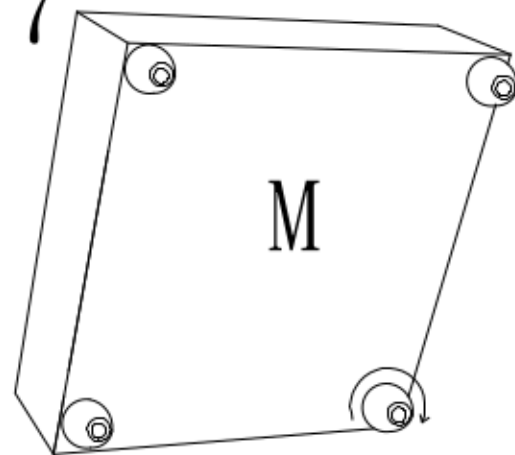

STEP 8

