

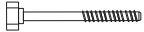

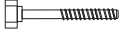











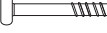





ASSEMBLY INSTRUCTION

PARTS LIST

PARTS	PATTERN	DESCRIPTION	QTY
A		Bolt	4
B		Bolt	4
C		Bolt	2
D		Chain Hook	2
E		Eye Bolt	2
F		Nut	12
G		Washer	22
H		Thread Bolt	8
I		Thread Bolt	8
J		Bolt Cap	8
K		Handle	2
L		Wrench	2
M		Allen Wrench	2
N		Allen Wrench	1
O		Arch Top	2
P		Arch Connect	2
Q		Bottom Arch Leg	2
R		Canopy Connect	2
S		Canopy Arm	4
T		Canopy Stop	4
U		Canopy Fabric	1
V		Hammock	1

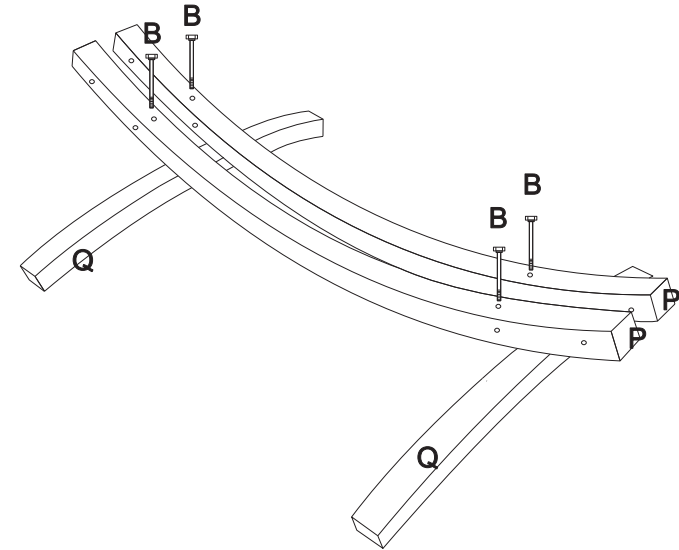

1

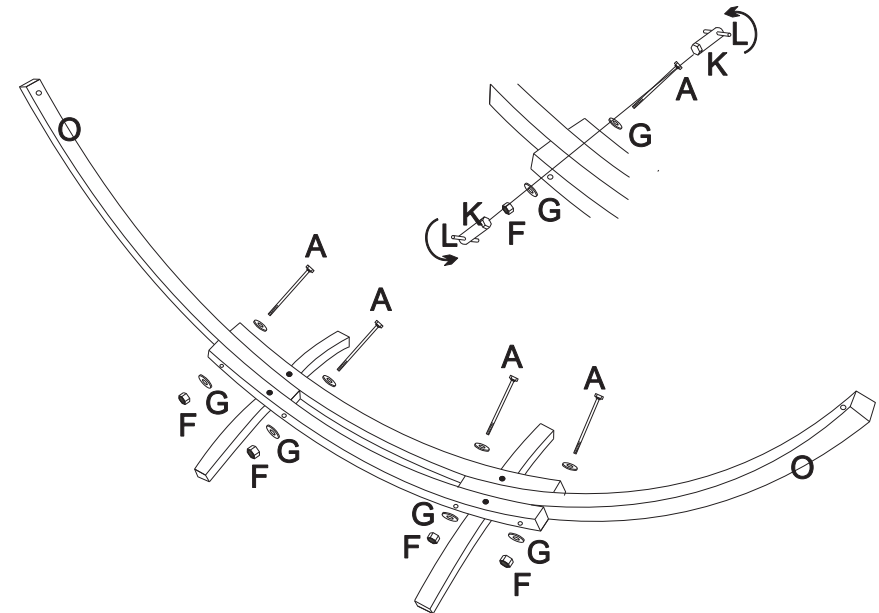

2

3

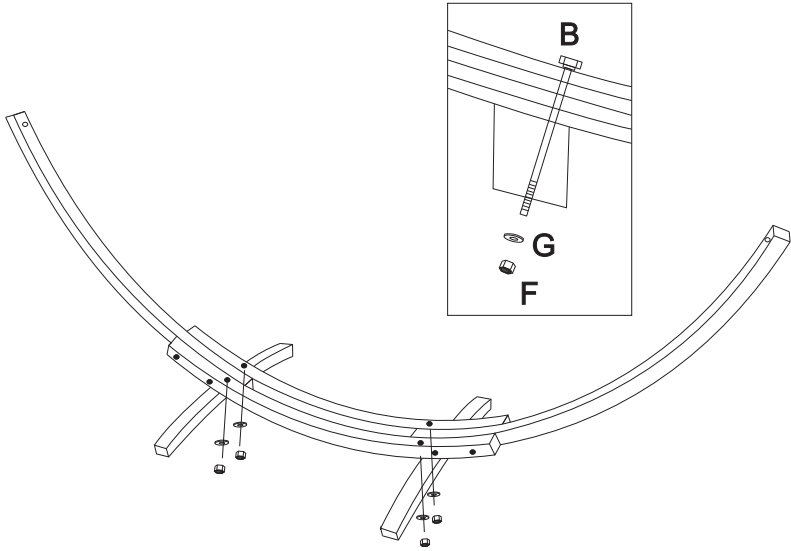

4

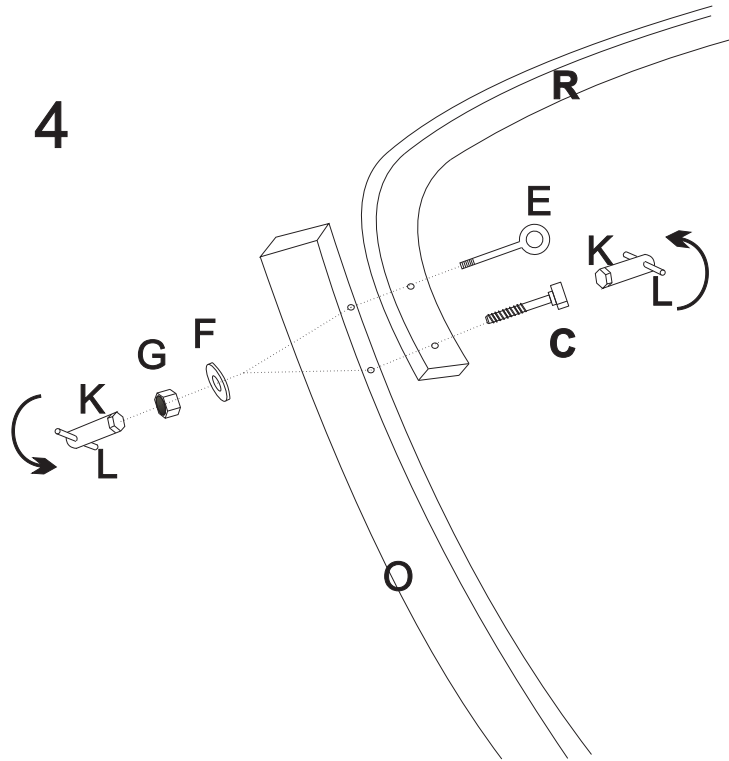

5

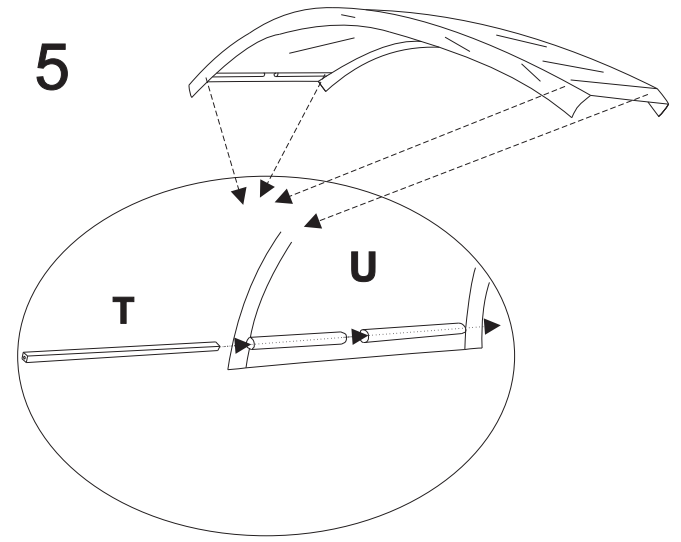

6

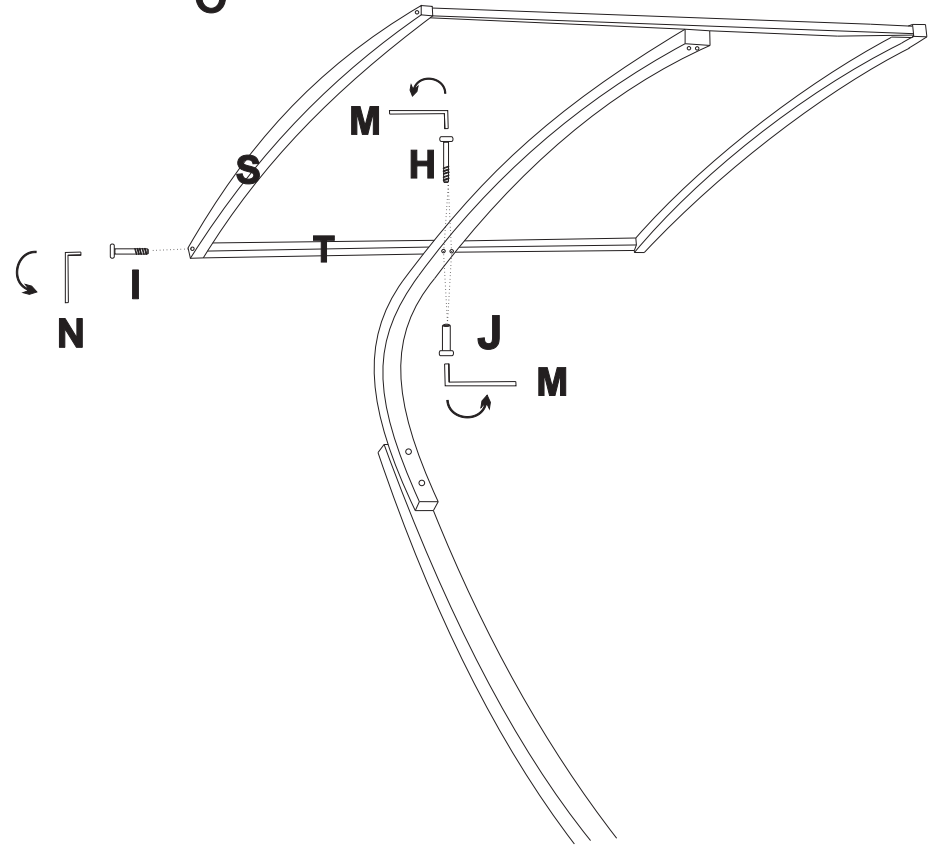

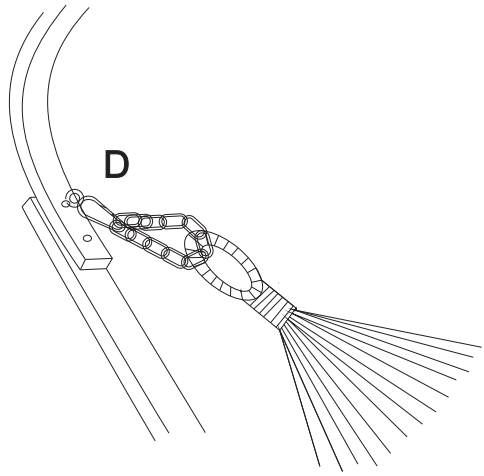

7

