

# hayneedle

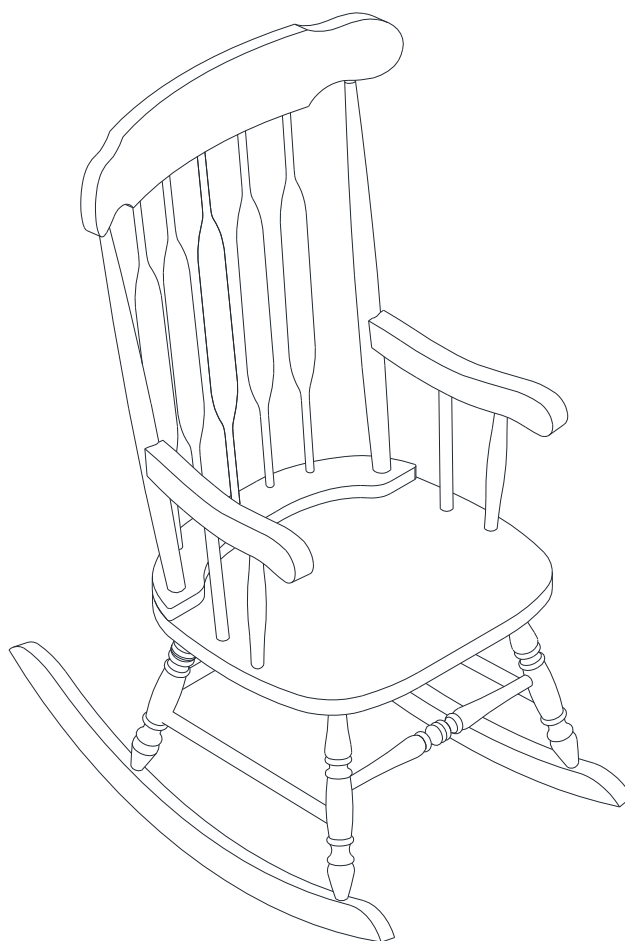

**ITEM NAME:** BELHAM LIVING NURSERY ROCKER

**SKU:** LIV030-1, LIV031-1, LIV032-1, LIV036-1



**For assistance with assembly, please contact  
Hayneedle Customer Care Center  
1-888-880-4884**

## PRE-ASSEMBLY PREPARATION:



THIS PACKAGE MAY CONTAIN SMALL ITEMS WHICH SHOULD BE KEPT AWAY FROM CHILDREN

- Please check that all parts and hardware are included before beginning assembly.
- Save all packing materials until assembly is complete to avoid accidentally discarding smaller parts or hardware.
- Read through the preparation and assembly instructions in full before beginning assembly.
- Please use CAUTION AND CARE WHEN LIFTING the product to avoid personal injury and (or) damage to the product.
- For ease of assembly, two adults are recommended.

## PARTS IDENTIFICATION:

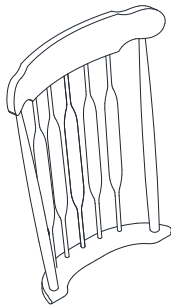

CHAIR BACK (A)  
788 x 646x 143 mm

Qty:1

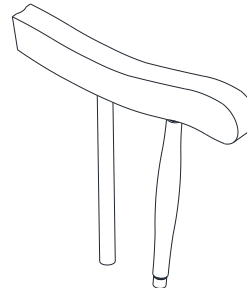

LEFT ARM (B1)  
355 x 319 x 43 mm

Qty:1

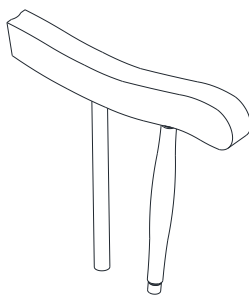

RIGHT ARM (B2) Qty: 1  
355 x 319 x 43 mm

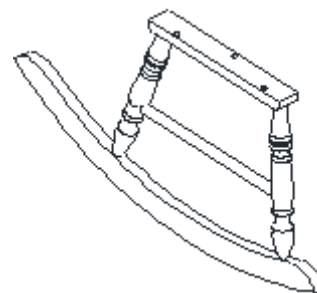

LEFT LEG (C1)  
832 x 380 x 49 mm

Qty: 1

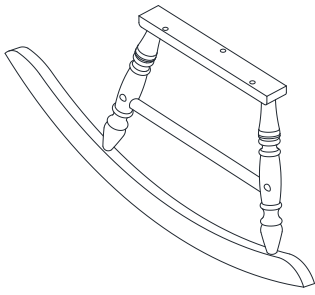

RIGHT LEG (C2)  
832 x 380 x 49 mm

Qty:1

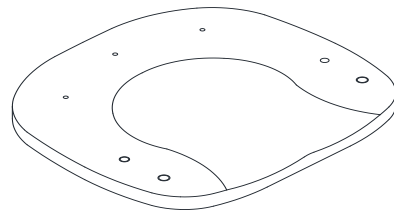

SEAT (D)  
496 x 550 x 28 mm

Qty:1

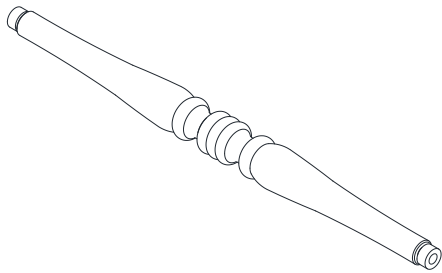

FRONT STRETCHER (E)

Qty:1

415 x 32 x 32mm

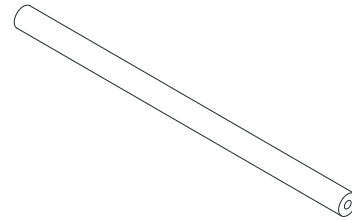

BACK STRETCHER (F)

Qty:1

387 x 22x 22mm

**HARDWARE LIST:**

**Scaled to Actual Size**

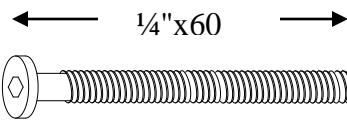

Long Bolt (1) Qty: 8

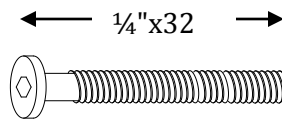

Short Bolt (2) Qty: 9

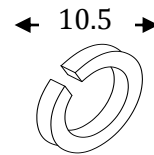

Lock Washer (3) Qty: 17

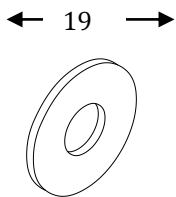

Big Flat Washer (4) Qty: 2

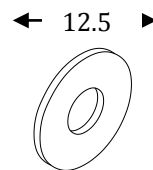

Small Flat Washer (5) Qty:15



Allen Key (6) Qty: 1

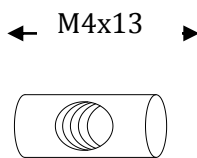

Barrel nut (7) Qty: 6

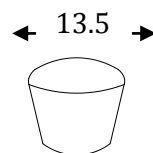

Wood Plug (8) Qty: 9

## STRUCTURAL DIAGRAM:

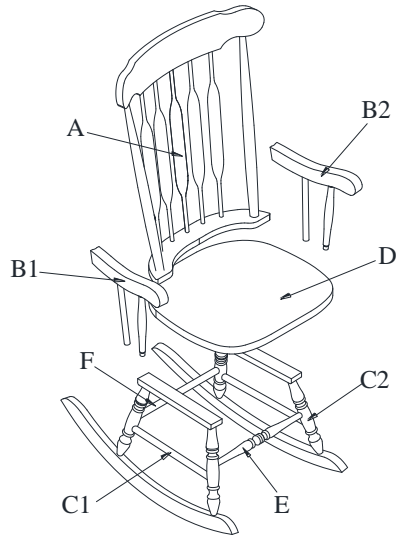





### Additionally Assembly Notes:

- Read these instructions carefully before assembling.
- Wait to dispose of the packing material until assembly is complete and all parts and hardware are accounted for.
- More than one person might be required for assembly. Check fasteners periodically to be sure they do not loosen.

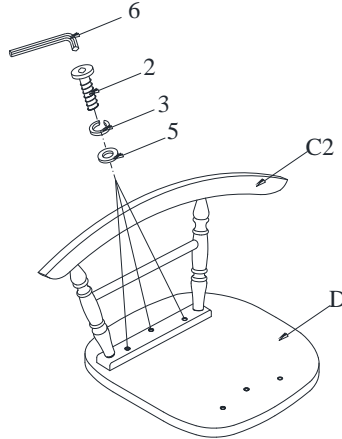
## STEP-BY-STEP ASSEMBLY:

- 1 STEP 1:** Place wood seat **(D)** upside down on soft surface, align and hand tighten right Leg **(C2)** to wood seat using short bolt **(2)**, lock washer **(3)** and small flat washer **(5)**, tighten all bolt with Allen Key **(6)**.



3 PCS	3 PCS	3 PCS	1 PC
			
Short Bolt (2) 1/4 "x32mm	Lock Washer (3) 1/4 "x10.5mm	Small Flat Washer (5) 1/4 "x12.5mm	Allen Key (6) M4x60mm

2

**STEP 2:** Insert barrel nut (7) into stretchers (E) (F). Align and fasten front (E) and back (F) stretchers to Right leg frame (C2) using long bolt (1), lock washer (3) and Small flat washer (5), tighten with Allen key (6). Insert wood plug (8) into the leg.

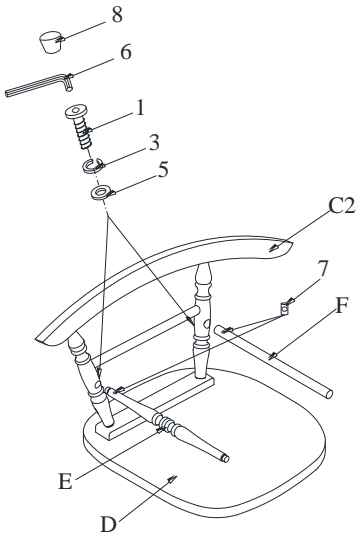





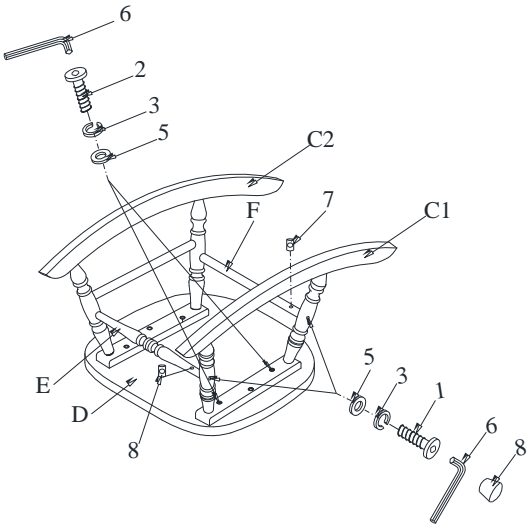

2 PCS	2 PCS	1 PC
Lock Washer (3) 1/4"x10.5mm	Small Flat Washer (5) 1/4"x12.5mm	Allen Key (6) M4x60mm
2 PCS	2 PCS	2 PCS
Long Bolt (1) 1/4"x60mm	Barrel Nut (7) 1/4 "x13mm	Wood Plug (8) φ13.5x8mm

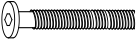
3

**STEP 3:** Insert barrel nut (7) into stretchers (E) (F). Align and fasten front (E) and back(F) stretchers to left leg frame (C1) using long bolt (1), lock washer (3) and Small flat washer (5), tighten with Allen key (6). Then align and hand tighten left leg frame (C1) to wood seat (D) using short bolt (2), lock washer (3) and small flat washer (5). Insert wood plug (8) into the leg.





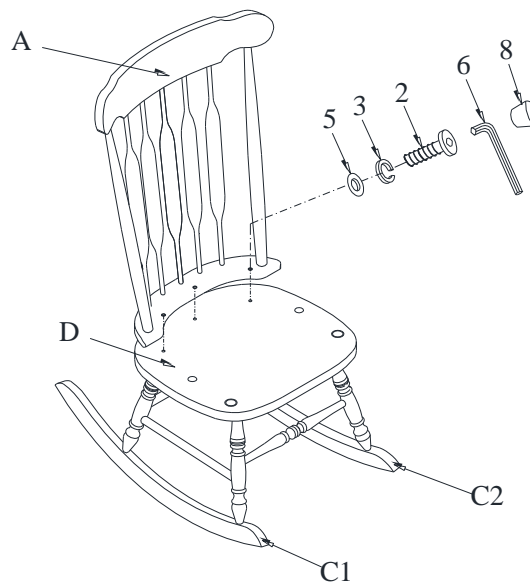

3 PCS	5 PCS	5 PCS	1 PC
			
Short Bolt (2) 1/4 "x32mm	Lock Washer (3) 1/4"x10.5mm	Small Flat Washer (5) 1/4"x12.5mm	Allen Key (6) M4x60mm
2 PCS	2 PCS		2 PCS
			
Long Bolt (1) 1/4"x60mm	Barrel Nut (7) 1/4 "x13mm		Wood Plug (8) φ13.5x8mm

**STEP 4 :** Align and fasten chair back **(A)** to wood seat **(D)** using short bolt **(2)**, lock washer **(3)** and small flat washer **(5)** then tighten with Allen key **(6)**. Insert wood plug **(8)** into the chair.

4

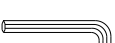





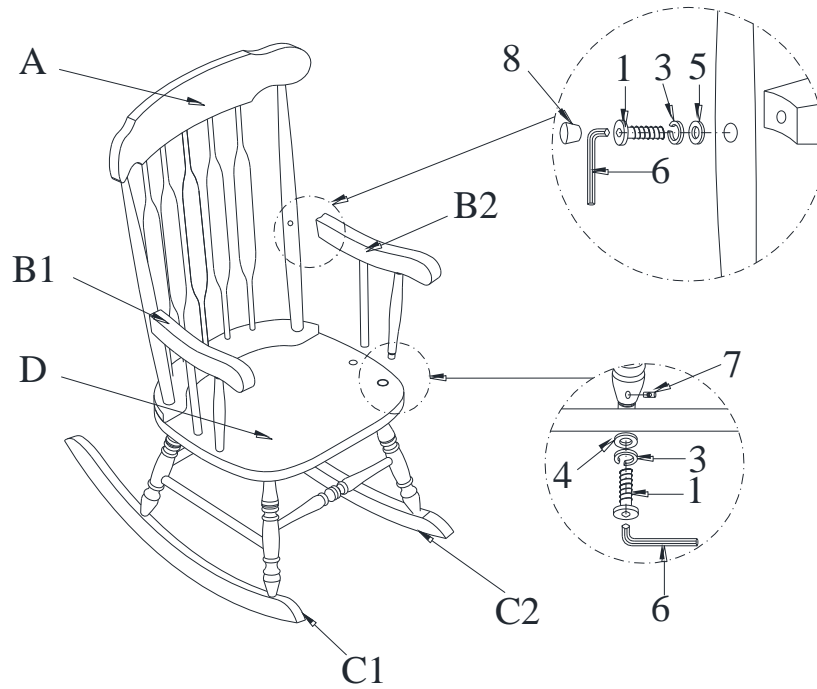

3 PCS	3 PCS	3 PCS	1 PC	3 PCS
				
Short Bolt (2) 1/4"x32mm	Lock Washer (3) 1/4 "x10.5mm	Small Flat Washer (5) 1/4 "x12.5mm	Allen Key (6) M4x60mm	Wood Plug (8) φ13.5x8mm

5

**STEP 5 :** Insert barrel nut (7) into front post of arm rest (B1)(B2). Align and fasten left (B1) and right (B2) arm rest to chair back (A) using long bolt (1), lock washer (3) and small flat washer (5) and tighten with Allen key (6). Fasten the arms to the seat (D) using long bolt (1), lock washer (3) and big flat washer (4) and tighten with Allen Key (6). Insert wood plug (8) into the chair.

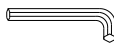

4 PCS	4 PCS	2 PCS	2 PCS	1 PC	2 PCS
					
Long Bolt (1) 1/4"×60mm	Lock Washer (3) 1/4"×10.5	Big Flat Washer(4) 1/4"×19mm	Small Flat Washer(5) 1/4"×12.5mm	Allen Key (6) M4×60mm	Wood Plug(8) φ13.5×8mm



**For assistance with assembly, please contact customer service  
1-888-880-4884**