

# hayneedle

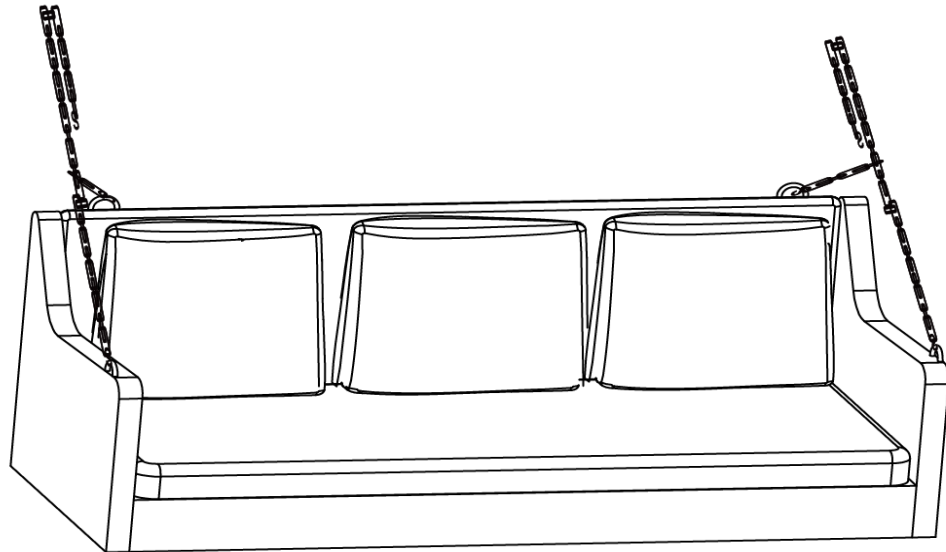

ITEM NAME: Belham Living Hagewood All Weather Wicker Porch Swing Bed

SKU: HONG122-1



**For assistance with assembly, please contact customer service  
1-888-880-4884**

## PRE-ASSEMBLY PREPARATION:



**DO NOT LET CHILDREN PLAY IN OR AROUND THE UNIT DUE TO THE POSSIBLE RISK OF FINGER ENTRAPMENT.**

- Please read through the instructions before beginning assembly.
- Two adults are recommended for assembly.
- Clear out the space for assembly and lay out all of the parts based on the Parts List, extra room will allow you to easily determine if all the pieces are present.
- Save all packing materials until assembly is complete to avoid accidentally discarding smaller parts or hardware.
- Keep small parts and pieces away from children until fully assembled.
- Ensure that all bolts are securely tightened before use. It is recommended that you re-check all nuts and bolts
- Do not swing in the chair beyond the parameter of the base as doing so may result in the chair tipping over and
- Use on even surfaces only.
- Improper use of this product or failure to use as directed may result in injury.

## PANEL AND FITTINGS IDENTIFICATION:

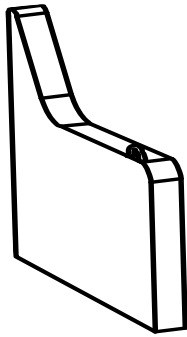

Right arm(A) Qty: 1

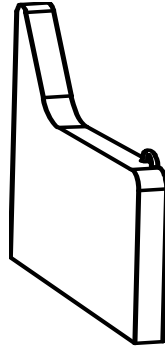

Left arm(B) Qty: 1

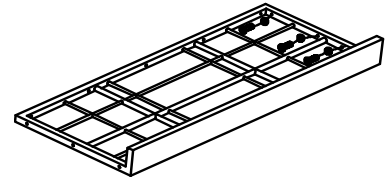

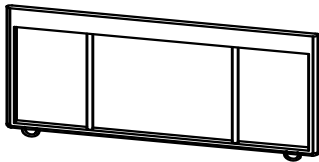

Seat(C) Qty: 1

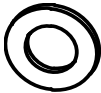

Back(D) Qty: 1

## HARDWARE LIST:

		
Bolt (E) Qty: 15	Washer (F) Qty: 15	Allen wrench (G) Qty: 1
		
Chain (H) Qty: 2		

## STEP-BY-STEP ASSEMBLY:

- 1 Step 1: Attach seat(C) to right arm(A) and left arm(B) by using 6 bolts (E) and 6 washers (F), tighten with allen wrench(G).

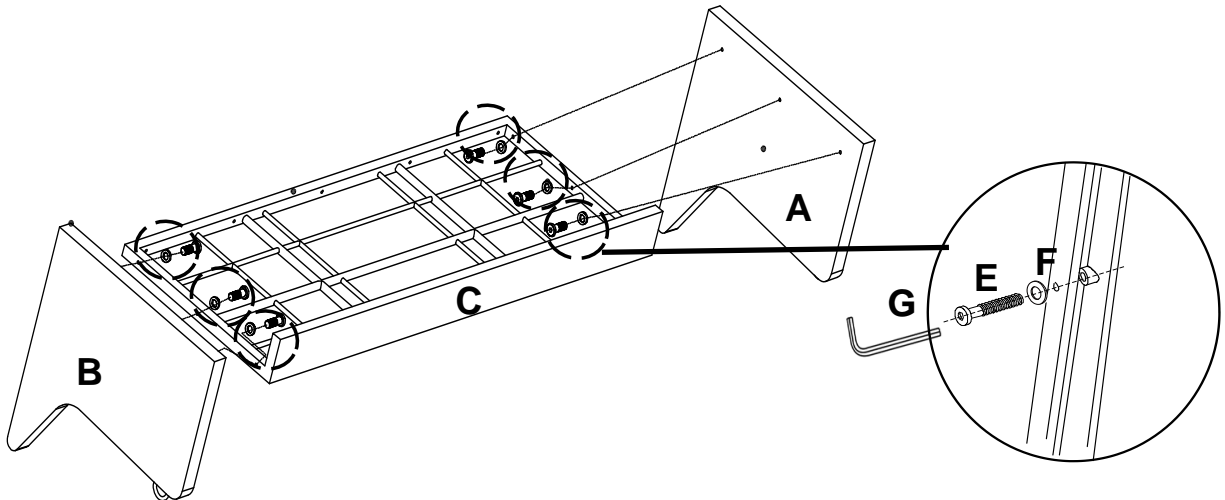

2

Step 2: Attach back(D) to seat(C) by using 5 bolts (E) and 5 washers (F), tighten with allen wrench(G). Attach back (D) to right arm (A) and left arm (B) by using 4 bolts (E) and 4 washers (F), tighten with allen wrench (G).

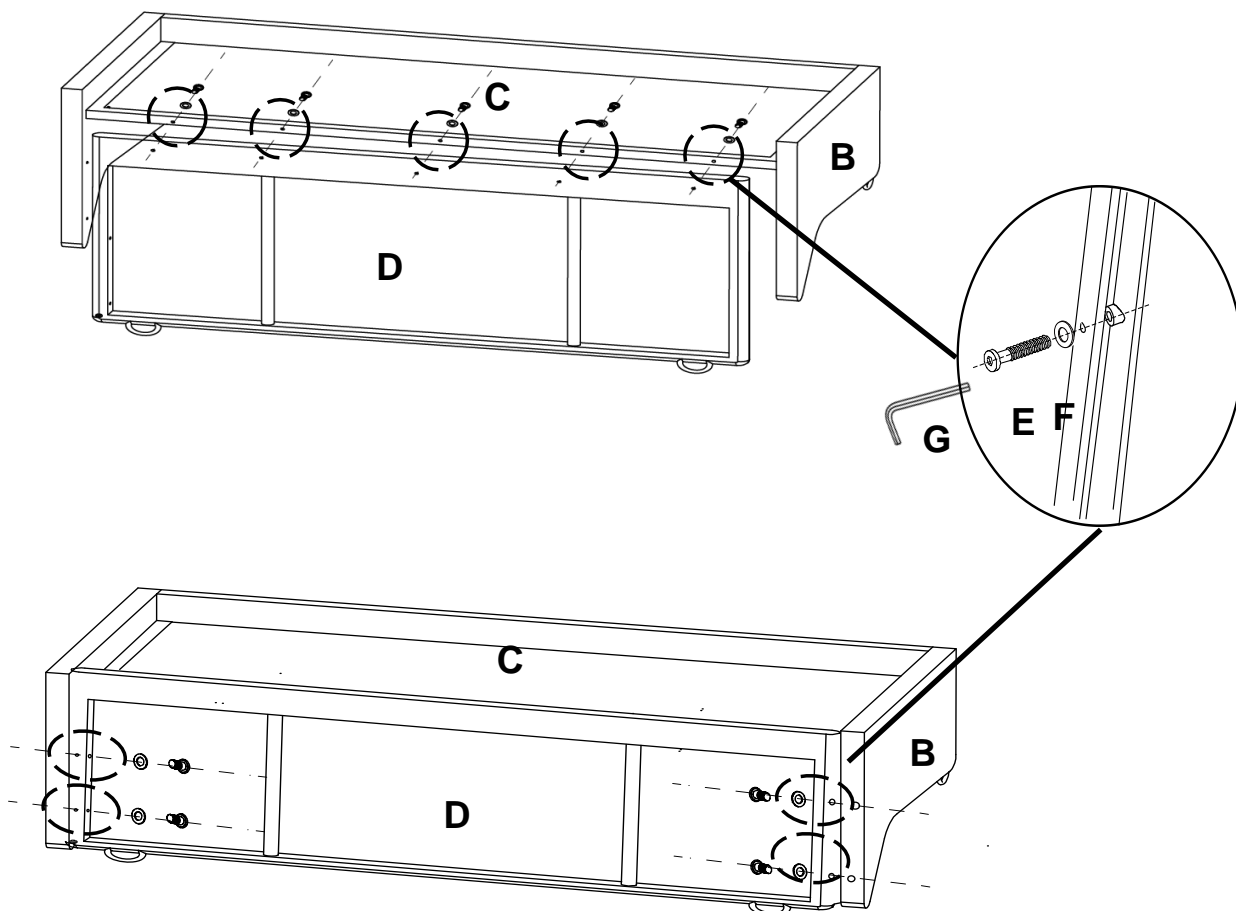

3

Step 3: Hang two Chains (H) to the Swing by four connection points. This Swing is for hanging on porch or trees. ( If the length of chains is not enough, please prepare by yourself with some chains or ropes).

