

hayneedle

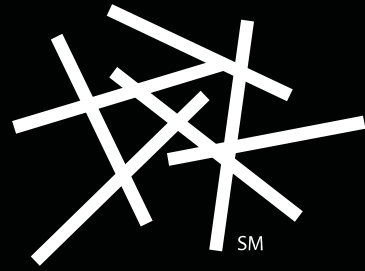

ITEM NAME:Wall Scroll Locking Jewelry Armoire

SKU:EWB327-1/EWB328-1/EWB329-1/EWB614-1/EWB620-1

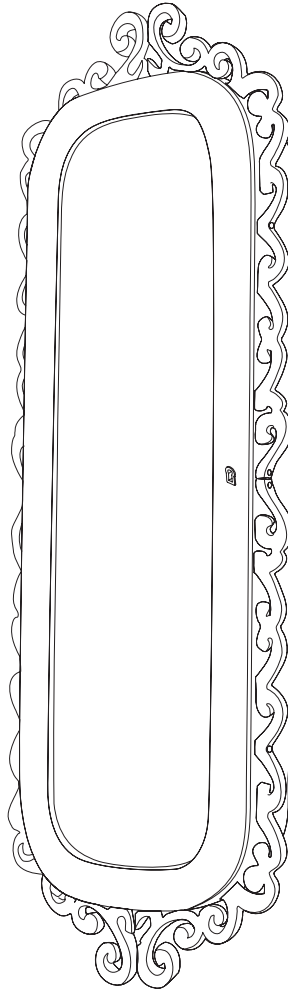

For assistance with assembly, please contact

Hayneedle Customer Care Center

1-888-880-4884

PRE-ASSEMBLY PREPARATION:



THIS PACKAGE MAY CONTAIN SMALL ITEMS WHICH SHOULD BE KEPT AWAY FROM CHILDREN

- Please check that all parts and hardware are included before beginning assembly.
- Save all packing materials until assembly is complete to avoid accidentally discarding smaller parts or hardware.
- Read through the preparation and assembly instructions in full before beginning assembly.
- Please use CAUTION AND CARE WHEN LIFTING the product to avoid personal injury and (or) damage to the product.
- The following additional tools are required for assembly: drill/ hammer/ Philips screw driver [NOT PROVIDED IN HARDWARE PACKAGE].
- For ease of assembly, two adults are recommended.

PANEL AND FITTINGS IDENTIFICATION:

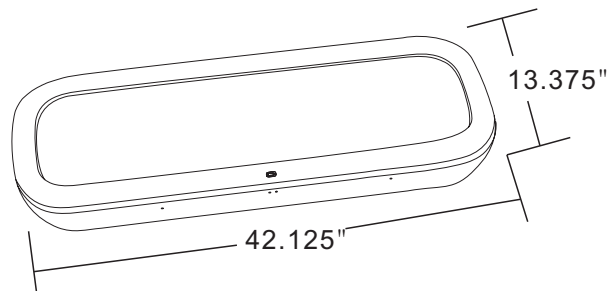

(A)

Qty:1

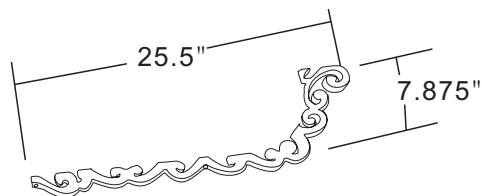

(B)

Qty:4

HARDWARE LIST:

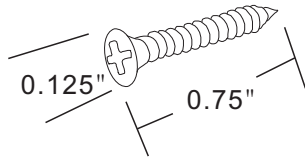

(C)

Qty:12

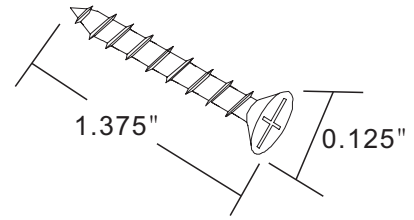

(D)

Qty:3

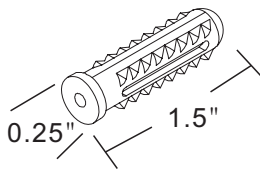

(E)

Qty:3

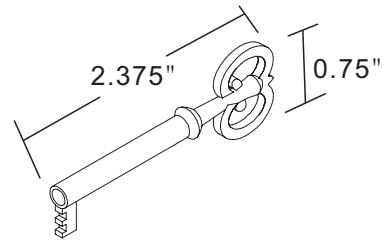

(F)

Qty:1

TOOLS REQUIRED:

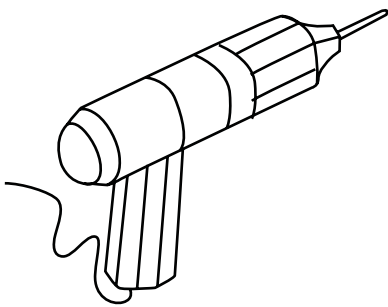

Drill

+

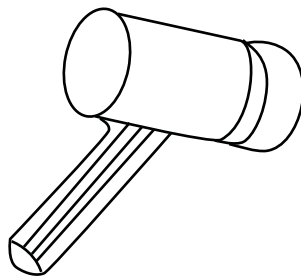

Hammer

+

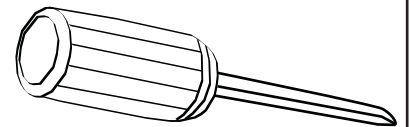

Philips screw driver

STRUCTURAL DIAGRAM:

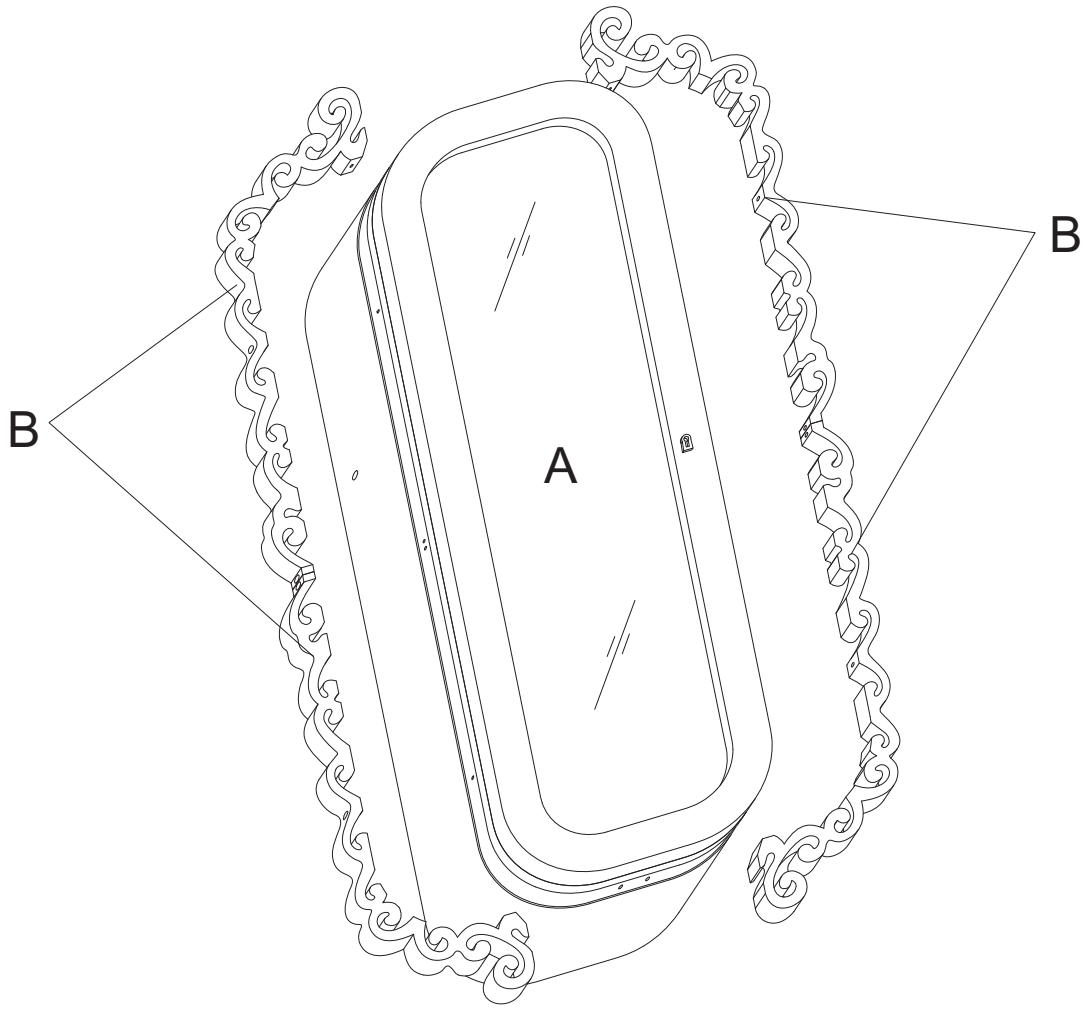

STEP-BY-STEP ASSEMBLY:

- STEP 1:** Lay the mirrored cabinet (A) on a soft surface (such as carpet), mirror side down. Attach four scroll edges (B) on the round of the mirrored cabinet lining up the holes using eight screws (C) and Philips screw driver.

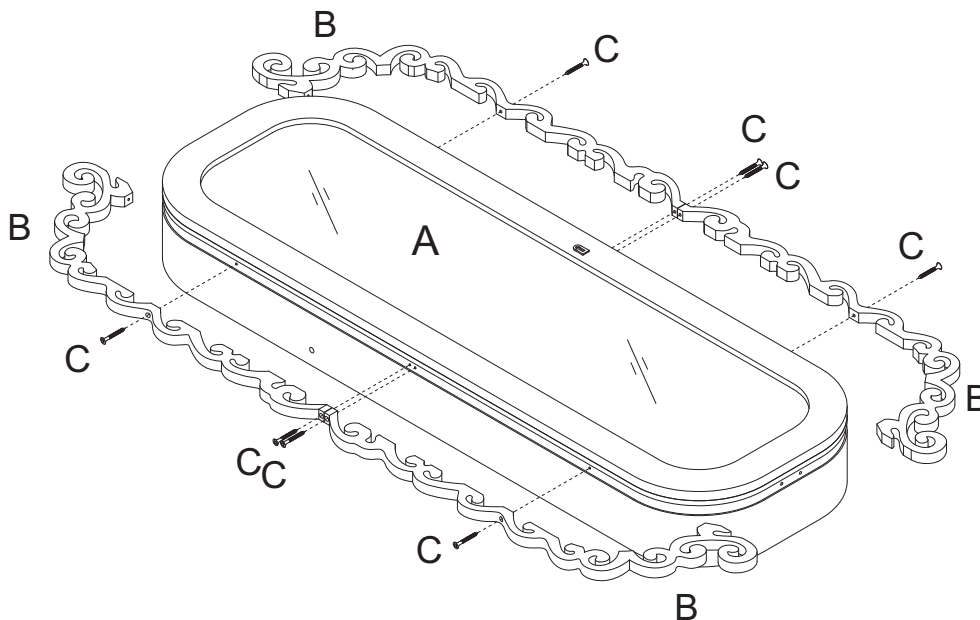

- STEP 2:** Insert two screws (C) into the top of mirrored cabinet (A) and two screws (C) into the bottom of mirrored cabinet (A) using Philips screw driver.

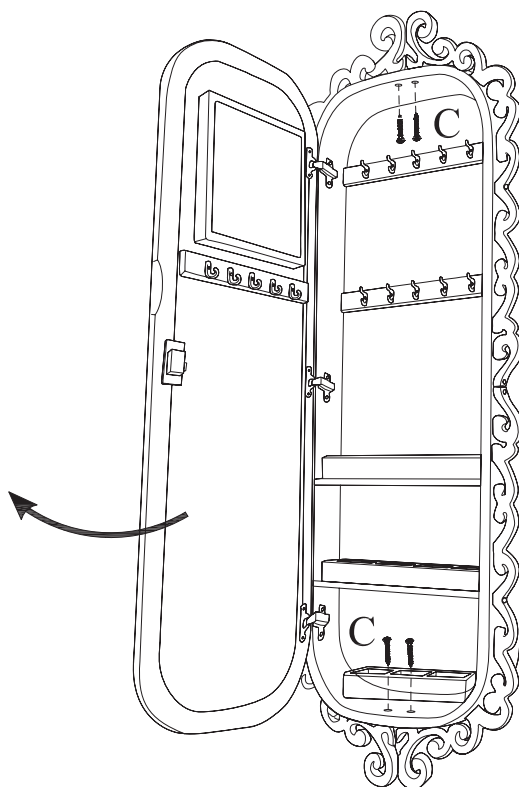

- 3** **STEP 3:** Insert the plastic plug (E) and screw (D) into the wall using the tools-drill / hammer / Philips screw driver.

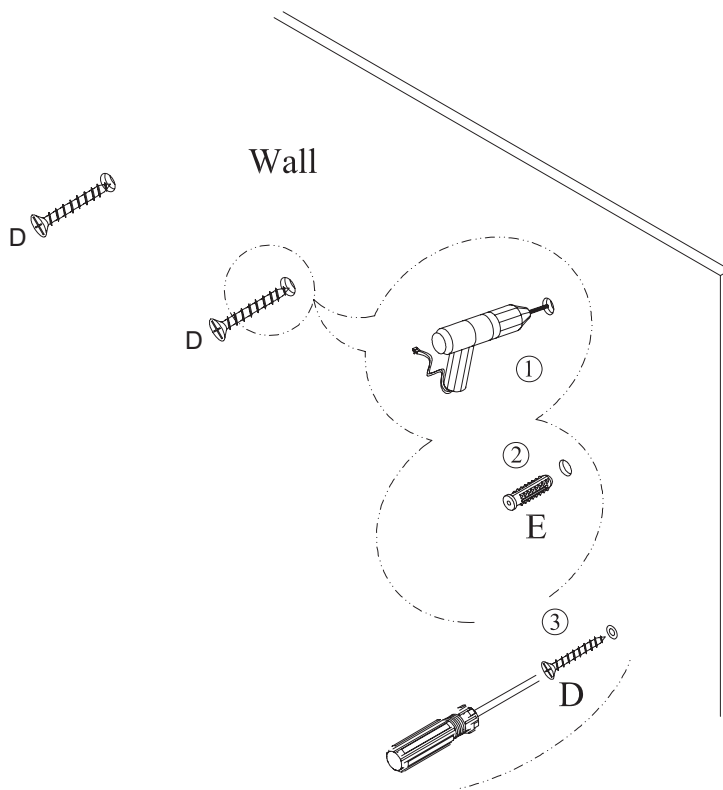

- 4** **STEP 4:** Insert the screw (D) through the metal plate hole into the plastic plug (E), make the whole one fix on the wall.

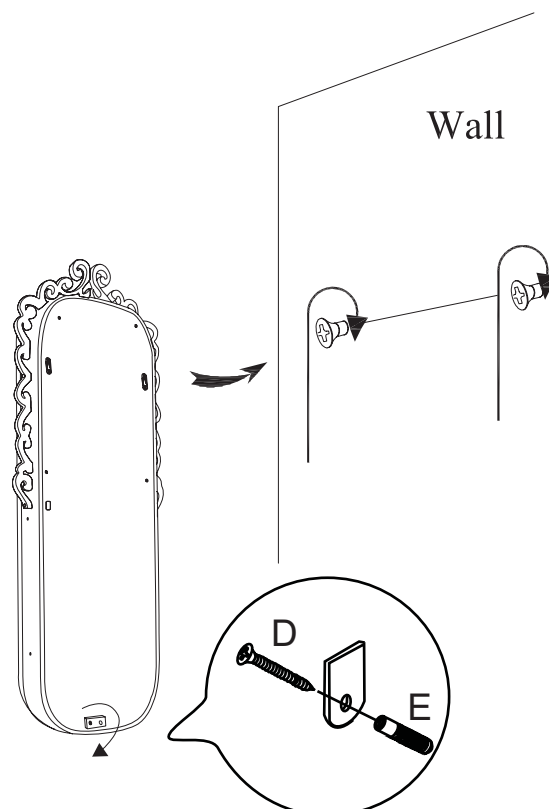

5 STEP 5: Don't forget to attach key.

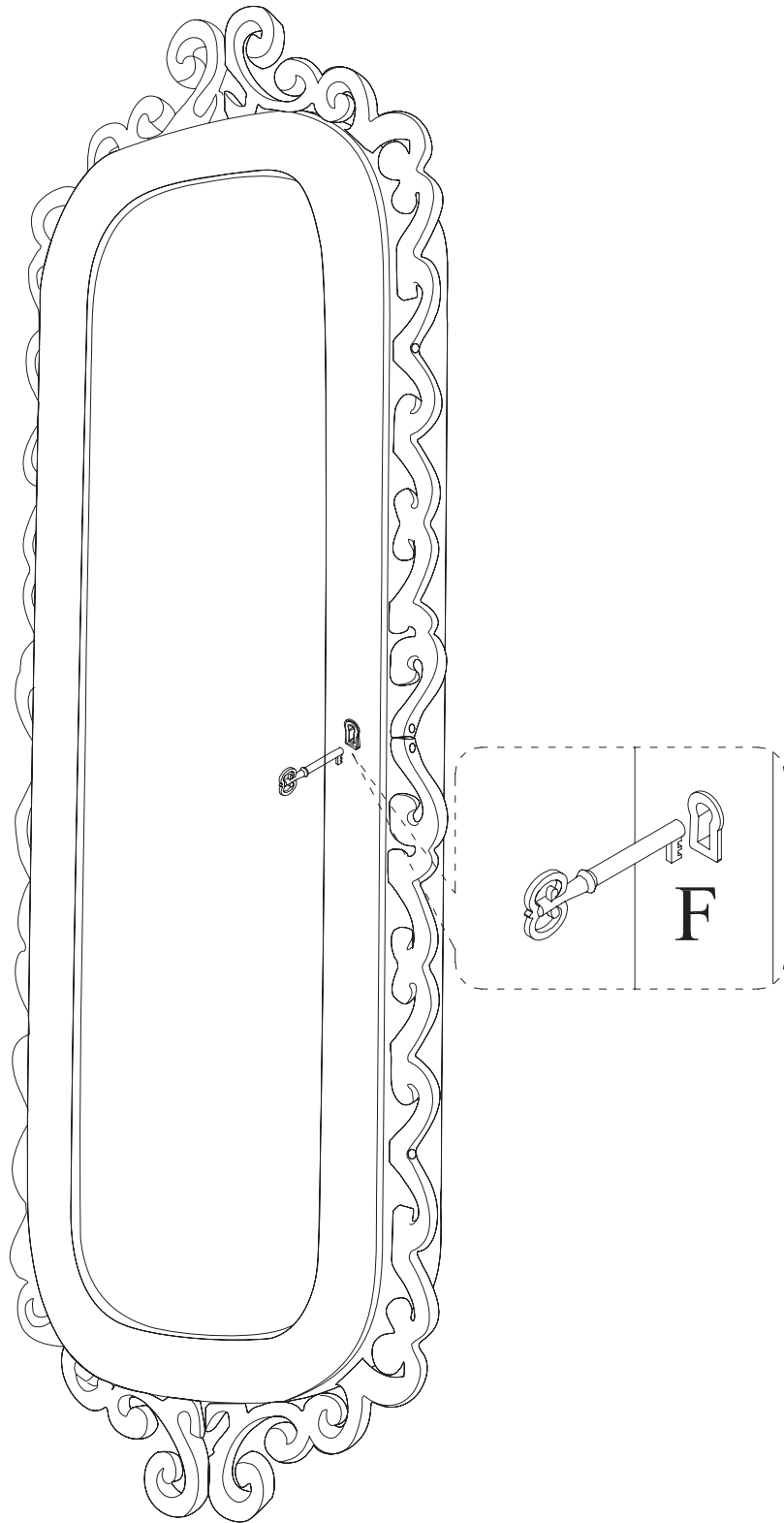



For assistance with assembly, please contact customer service
1-888-880-4884