

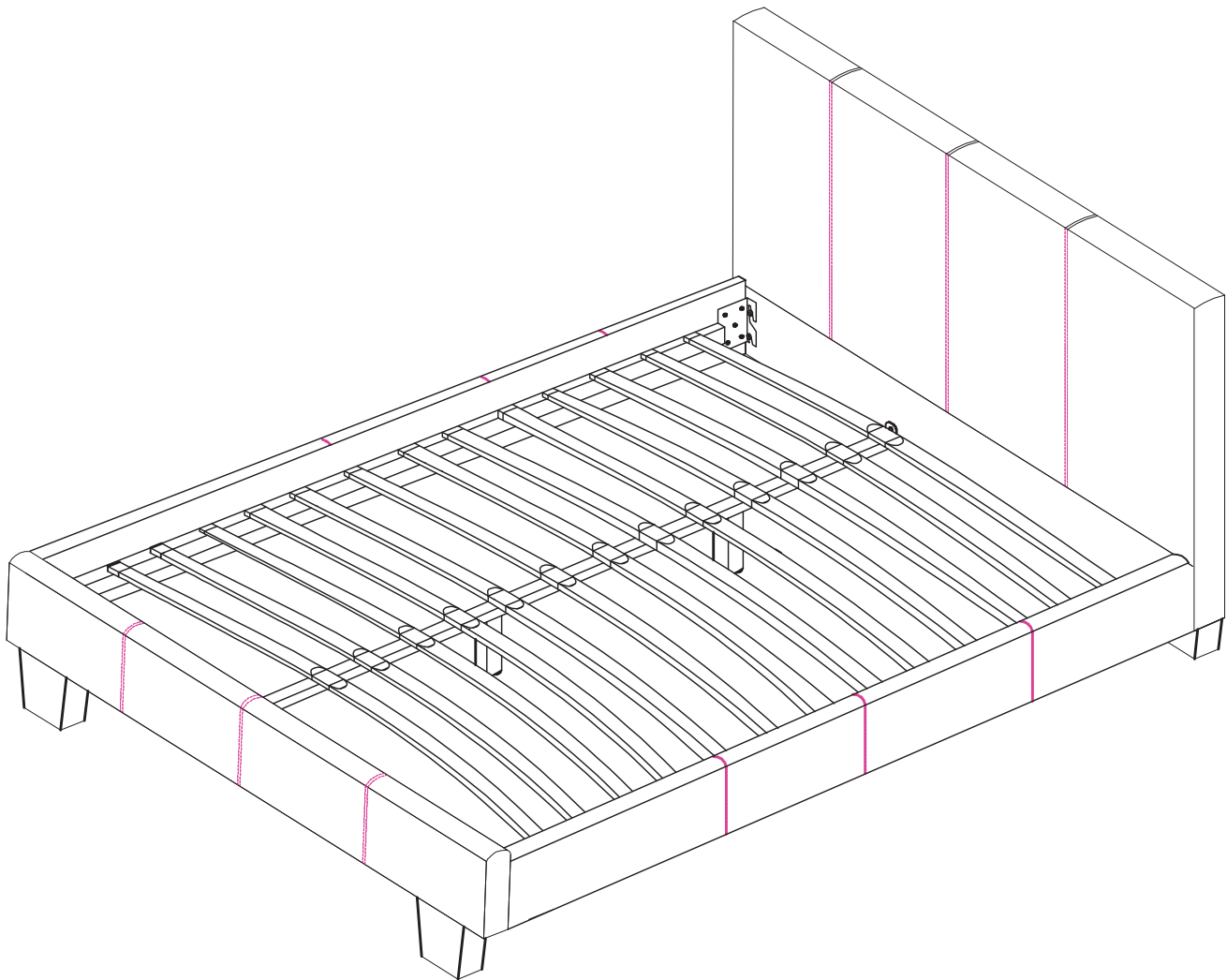









Furniture of America™









ASSEMBLY INSTRUCTION

Item No:CM7008Q/F



Do not tighten screws until completely assembled.

PARTS IDENTIFICATION			
NO	Part	Sketch	Quantity
1		HEAD BOARD	1PC
2		SIDE RAIL	2PCS
3		FOOT BOARD	1PC
4		CENTRAL SUPPORT RAIL	1PC
5		FEET	4PCS
6		BED SLATS	26PCS
7		SUPPORT LEGS	2PCS

HARDWARE LIST			
NO	Shape	Specification	Quantity
A		SCREW (M8x25mm)	8PCS
B		SCREW (M8x40mm)	6PCS
C		SCREW (M8x100mm)	8PCS
D		WASHER	22PCS
E		SPRING WASHER	22PCS
F		CENTER PLASTIC CONNECTOR	13PCS
G		END CAP	26PCS
H		WRENCH	1PC

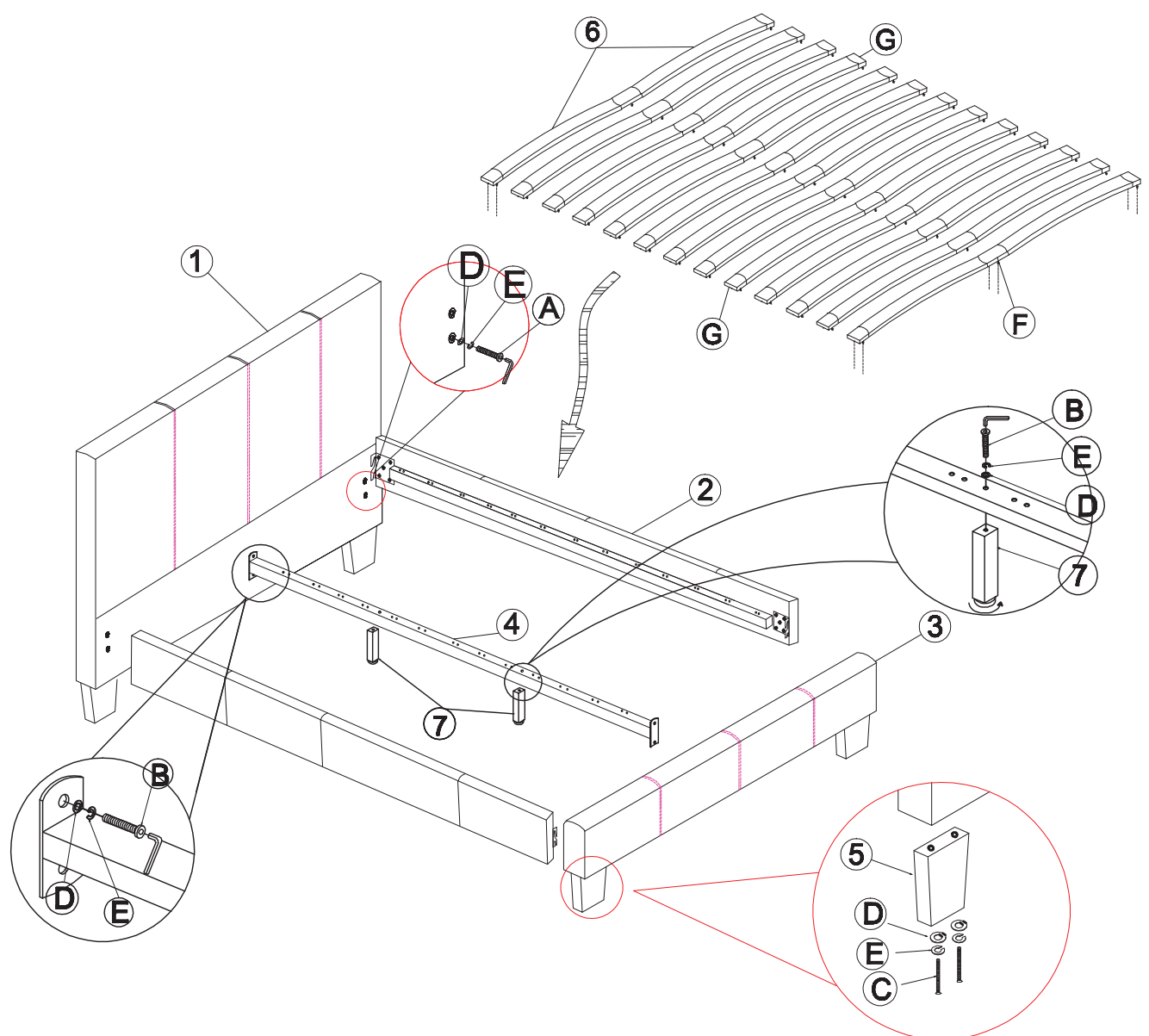

Do not tighten screws until completely assembled.