

# hayneedle

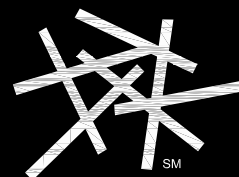

ITEM NAME: Belham Living Crosshatch Display Wall Shelf  
SKU:CHIS181-1,CHIS181-2

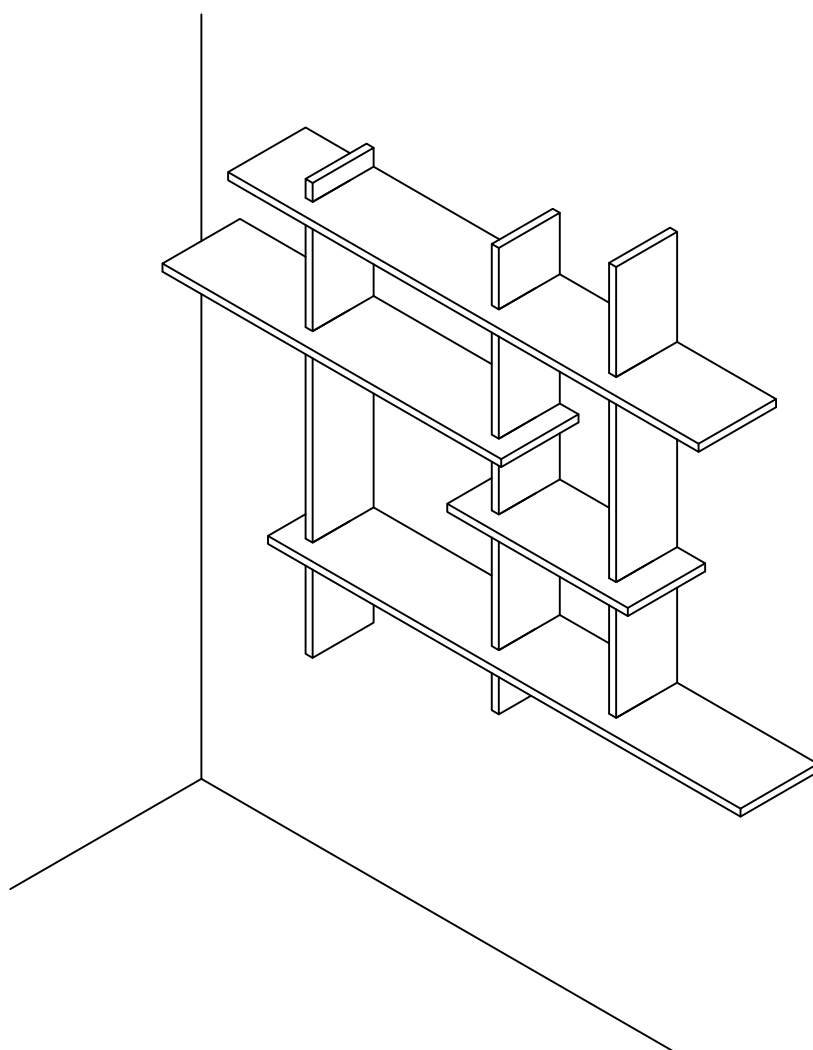

For assistance with assembly, please contact  
Hayneedle Customer Care Center  
1-888-880-4884

## PRE-ASSEMBLY PREPARATION:



THIS PACKAGE MAY CONTAIN SMALL ITEMS WHICH SHOULD BE KEPT AWAY FROM CHILDREN

- Please check that all parts and hardware are included before beginning assembly.
- Save all packing materials until assembly is complete to avoid accidentally discarding smaller parts or hardware.
- Read through the preparation and assembly instructions in full before beginning assembly.
- Please use CAUTION AND CARE WHEN LIFTING the product to avoid personal injury and (or) damage to the product.
- The following additional tools are required for assembly: Phillips head screwdriver, flat head screwdriver and rubber mallet.
- For ease of assembly, two adults are recommended.

## PARTS AND FITTINGS IDENTIFICATION:

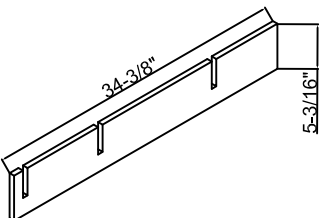
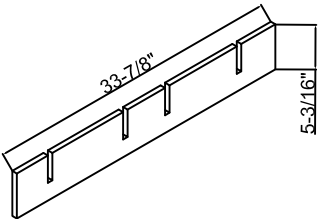
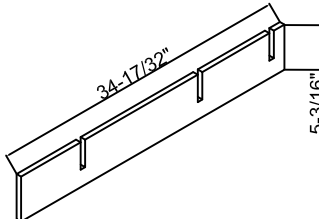
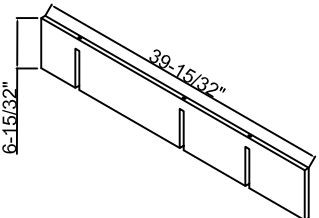
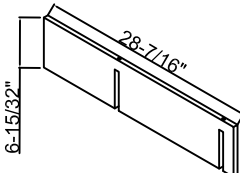
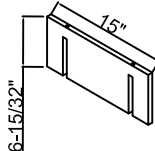
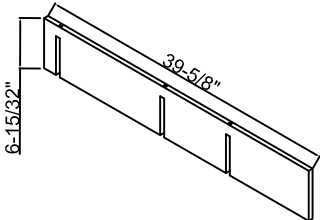
|  |  |  |
|--|--|--|
|  <p>panel(A) Qty: 1</p>  |  <p>panel(B) Qty: 1</p>  |  <p>panel(C) Qty: 1</p>  |
|  <p>panel(D) Qty: 1</p> |  <p>panel(E) Qty: 1</p> |  <p>panel(F) Qty: 1</p> |
|  <p>panel(G) Qty: 1</p> |  |  |
|  |  |  |

### HARDWARE LIST:

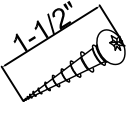
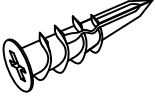
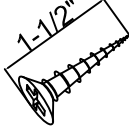
|   |   |  |  |
|---|---|--|--|
|  |  |  |  |
| Screws (1) Qty: 3   | Anchor (2) Qty: 3   | Screws (3) Qty: 10   |  |

### TOOLS REQUIRED:

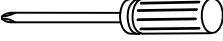
|   |  |  |  |
|---|--|--|--|
|  |  |  |  |
| (NOT INCLUDE) Qty: 1  |  |  |  |

STRUCTURAL DIAGRAM:

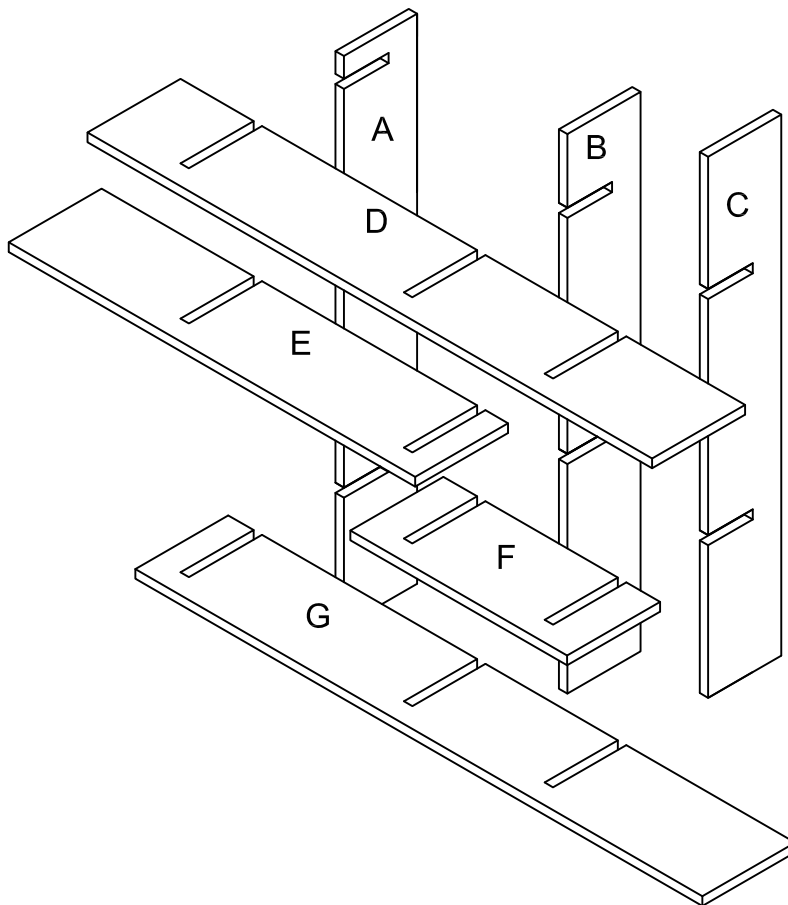

## STEP-BY-STEP ASSEMBLY:

### STEP 1: Attach Panel.

Attach the Divider Shelf (D& E&F&G) Insert to Vertical Divider (A&B&C) as shown.

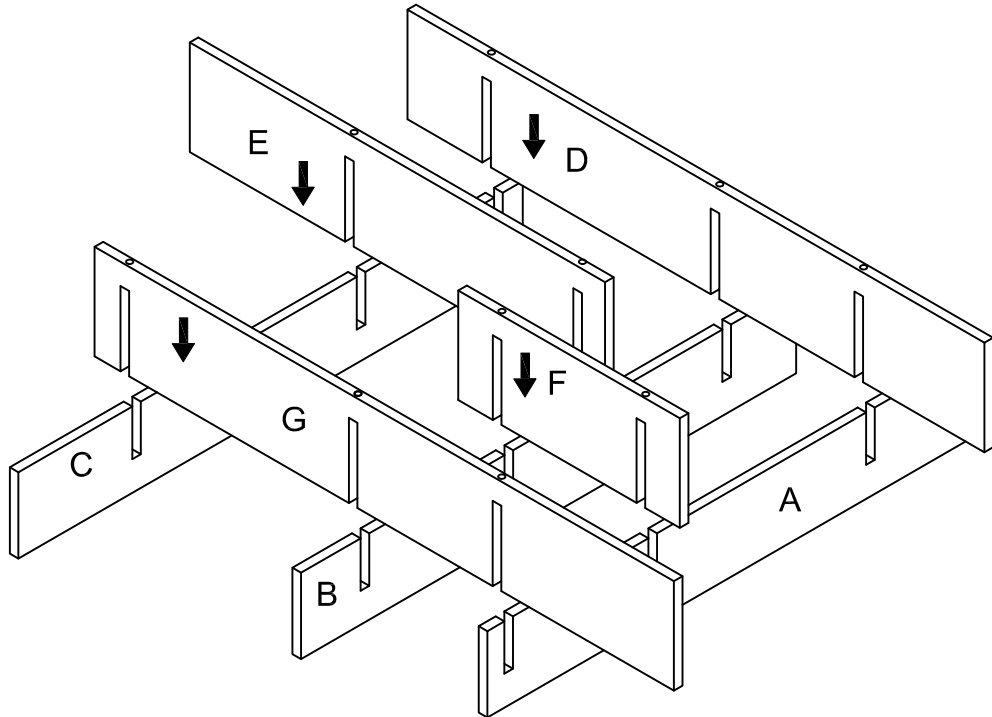

### STEP 2: Attach Panel.

Attach the 10 screws (3) to the panel (A/B/C) and tighten.

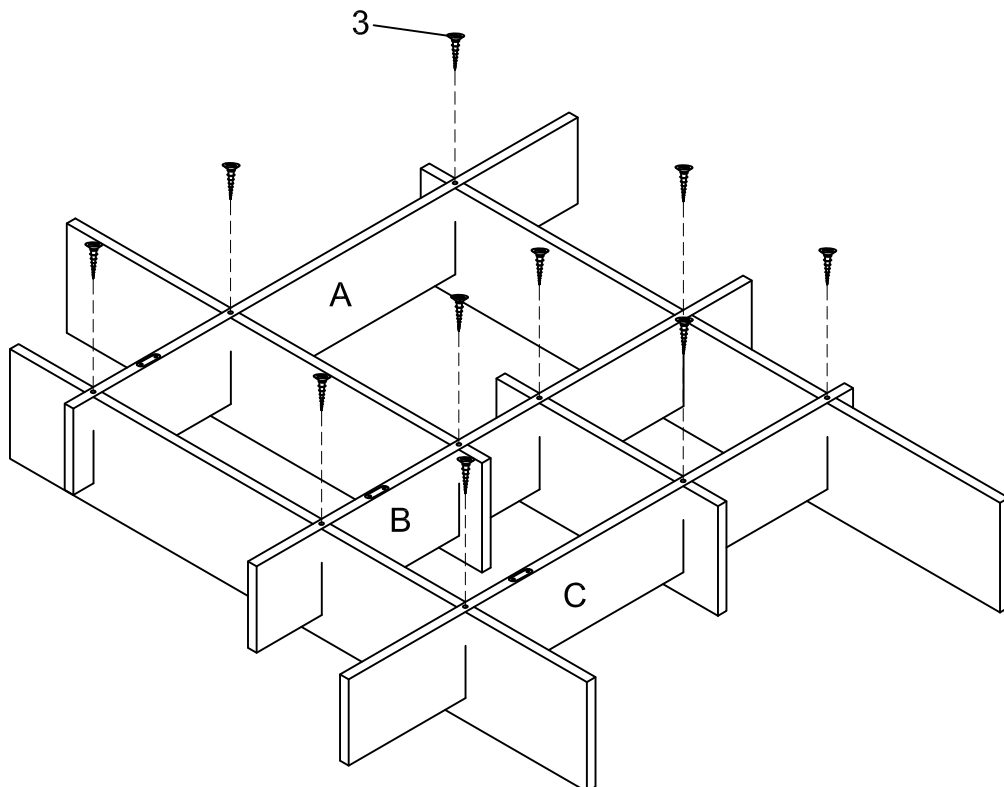

## STEP-BY-STEP ASSEMBLY:

### STEP 3: Attach the Wall.

Position unit in desired location against wall.

Place Anchors (2) into drilled holes.

Attach 3 Screws (1) to the Anchors (2) and tighten.

Put the panel (D) onto the Screws (1).

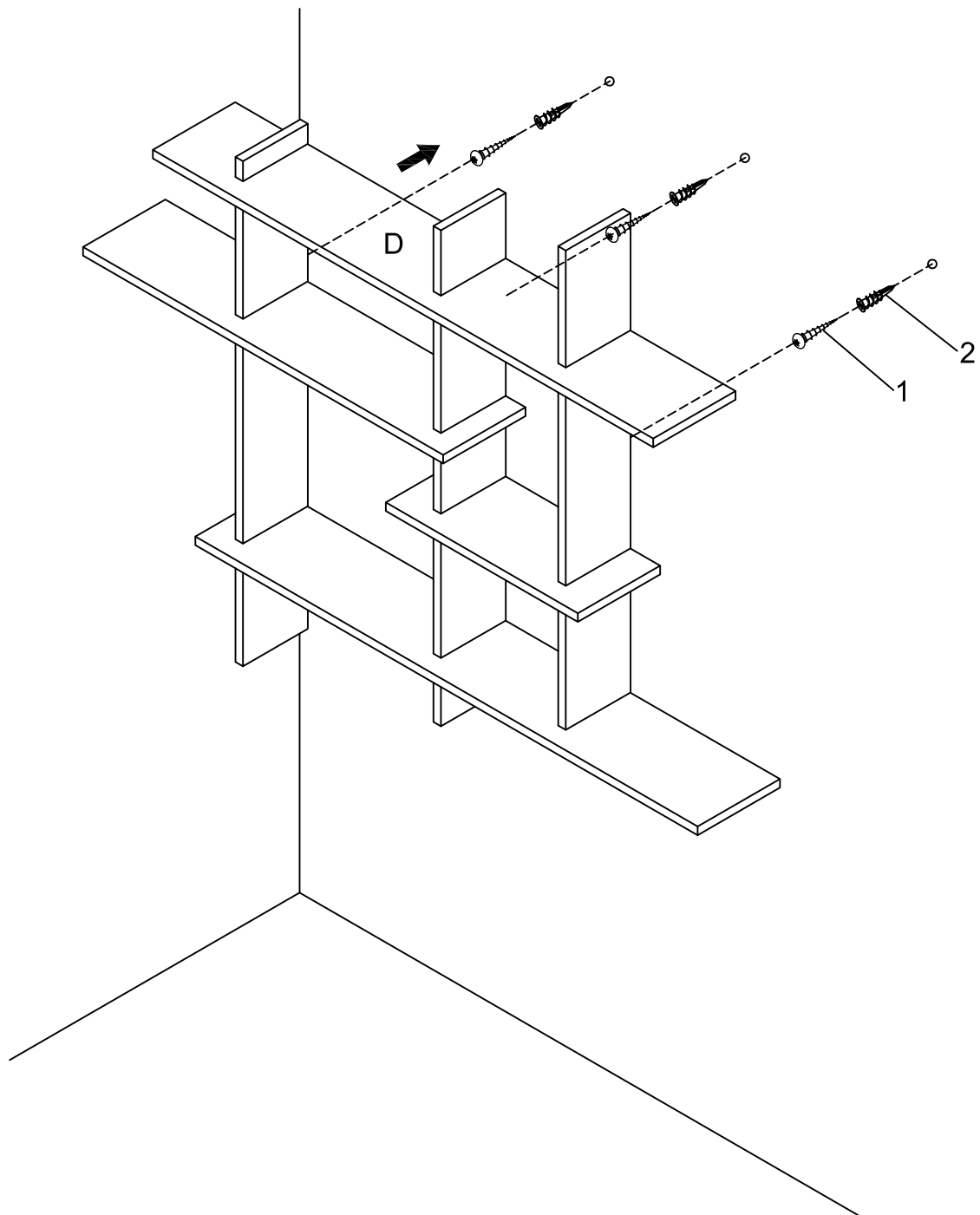



For assistance with assembly, please contact customer service  
1-888-880-4884