

**IMPORTANT!! PLEASE READ ENTIRE INSTRUCTION SHEET BEFORE ASSEMBLY!!
TO EXPEDITE ANY FUTURE WARRANTY CLAIMS, PLEASE KEEP INSTRUCTION SHEET, WARRANTY CARD AND RECEIPT**

Step 1: Identify all parts packed in the carton against the parts list. Remove all protective materials. Place parts on a non-abrasive surface to avoid scratching. If you are missing any parts or are unsure as how to proceed with the assembly, call our Customer Service Center at 1-800-416-3511. **Do not attempt assembly if any parts are missing or damaged.**

Step 2: Place the swivel base (with rocker assembly) on a flat, solid surface. Make sure the rocker assembly is positioned all the way into the base. It may have shifted or vibrated out during shipment.

Step 3: Important: We recommend 2 people work together to assemble the chair. Note the arrow labels on the "U" bar and the rocker assembly. Also note the horseshoe shape of the rocker plate. Point the open end of the horseshoe away from you. The arrows on the rocker assembly should be pointing towards you. Set the chair frame on the rocker assembly with front of the seat facing you and the arrows on the "U" bar pointing towards you as shown in *Figure 1*. This is very important for a safe, balanced rocking motion. **If chair frame has been properly positioned on the rocker assembly, all arrows on the "U" bar and rocker assembly will be pointing in the same direction.**

Step 4: Critical Step: The "U" metal plates must be installed in the proper location. Read this step and carefully examine. Insert the "U" metal plate, so that the "U" bar and rocker plate are between both sides of the "U" metal plate. Make sure that the holes in the "U" metal plate are completely aligned with the holes in the "U" bar as shown in *Figure 1*. Guide the bolts through the holes on the top side of the "U" metal plate, through the holes in the "U" bar portion of the chair, through the holes in the rocker plate and then, most importantly, through the holes in the bottom side of the "U" metal plate. It is very important that the holes in the bottom portion of the "U" metal plate be placed directly beneath the holes in the rocker plate. Add a spring washer and a nut to each bolt as shown in *Figure 2*. **Hand tighten nuts 3-4 revolutions only.** Repeat the same procedure on the other side.

CAUTION: Failure to place "U" metal plates under the rocker plates and above the "U" bar exactly as shown in diagram will cause the bolt heads and nuts to damage the structure of the rocker plates and the "U" bar. Damage due to over tightening of bolts or improper assembly could cause injury and may void your warranty.

Step 5: Tighten all nuts and bolts with the hex wrenches provided. **Ensure the bolts are FULLY tightened.** Remove arrow labels from "U" bar and rocker assembly. Cover bolts with bolt covers.

Step 6: Your chair should be ready for use. If your chair is not rocking properly, double-check your assembly procedure, especially Step 3. If the chair rocks too far forward to or is difficult to rock backwards, you have probably installed the seat frame backwards on the rocker assembly. If you need further assistance, please call our Customer Service Center at 1-800-416-3511.

IMPORTANT NOTE: Damage to frames or spring plates resulting from not FULLY tightening the bolts, is not covered under warranty. Please read all instructions carefully before assembly. If you have any questions regarding your assembly, call our Customer Service Center at 1-800-416-3511.

NOTE: MAKE SURE ARROWS FROM BOTH THE "U" BAR AND ROCKER ASSEMBLY ARE POINTING IN THE SAME DIRECTION!

SEAT DESIGNS MAY VARY BUT THE ASSEMBLY IS THE SAME

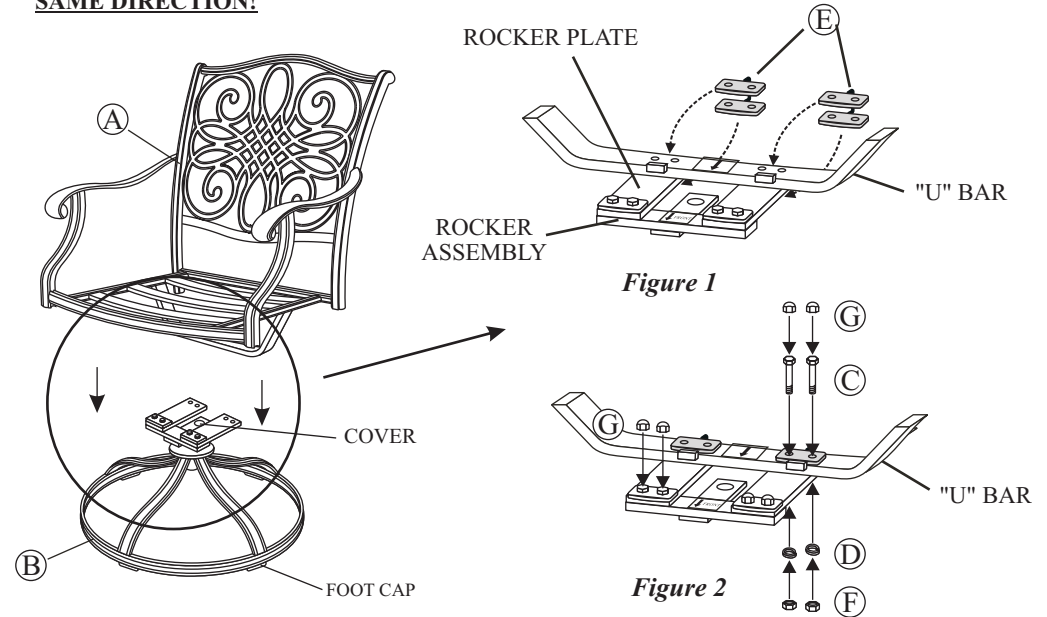

* NOTE: PARTS SHOWN ON PARTS LIST ARE NOT TO SCALE

	PARTS LIST	DESCRIPTION	ORDER PART #	QTY	PARTS LIST	DESCRIPTION	ORDER PART #	QTY
A		CHAIR FRAME		1		HEX WRENCH-1	HW0008	1
B		SWIVEL BASE & ROCKER ASSEMBLY		1		HEX WRENCH-2	HW0007	1
C		5/16" X 40 MM BOLT	HW0295	4		ROCKER PLATE FACTORY ASSEMBLY	SF0F2115B	
D		Ø8.0 X 2.3 MM SPRING WASHER	HW0003	4		COVER FACTORY ASSEMBLY	G0161	
E		"U" METAL PLATE	HW0618	2		FOOT CAP FACTORY ASSEMBLY	FC0031	
F		5/16" NUT	HW0015	4				
G		BOLT COVER	HW0028	8				

AAF06001

CARE AND MAINTENANCE

FRAMES

Cleaning - Use mild soap and warm water. Do not use abrasive materials, cleansers or bleach products. Rinse with clean water and dry thoroughly.

Maintenance - Periodically clean and dry thoroughly. Be sure to drain any water accumulated inside the frames. To thoroughly drain frames, remove foot caps and tilt the frames, if necessary, to remove all water. This is critical. Water allowed to accumulate inside the frames and then exposed to sub-freezing temperatures can cause damage to the frame tubing. Such damage is not covered under warranty. Always clean, drain and dry thoroughly before storing for the winter. For best results, always store or cover your furniture when not in use. We recommend commercially available outdoor furniture covers. Any small nicks or scratches can be covered with a light application of touch-up paint.

** When cleaning or moving large or heavy items, always have two people work together. Never drag furniture.

FABRICS (CUSHIONS/SLINGS)

Cleaning - Wipe minor spills immediately. Clean with mild soap, warm clean water and soft cloth. Do not use abrasive materials, cleansers or bleach products. Although fabric has been treated to resist stains, occasional use of commercially available fabric cleaners may be necessary. Follow manufacturer's instructions.

Maintenance - The best way to maintain the beauty of cushions and slings is to store them in a dry area and out of the elements when not in use or cover with commercially available outdoor furniture covers.

STRAPS

Cleaning - Wash frequently with mild soap, warm water and a soft cloth. Rinse thoroughly with warm, clean water. Do not use abrasive materials, cleansers or bleach products.

Maintenance - Periodic application of commercially available vinyl cleaners and vinyl protectors will enhance the look and prolong the life of straps. If your strap chair has cushions, make sure any vinyl protectors applied are completely dry before placing cushion back on the chair.

LIMITED WARRANTY

- **Frames.** Frame construction is warranted against defects in material and workmanship for seven years from purchase date. Damage to frames or welds resulting from improper assembly or exposure to water and/or sub-freezing temperatures is not covered.
- **Finishes.** Paint finishes are warranted against peeling, cracking and blistering for one year from purchase date provided the unit has not been scratched or abraded. Chips and scratches resulting from normal wear and tear are not covered.
- **Fabrics.** Fabric and cushions (if applicable) are warranted against separation at the seams for one year from purchase date. Fading and/or discoloration resulting from exposure to the elements, oils, spills, fluids, chemicals, or any other cause is not covered.
- **Straps and/or wicker.** Straps and/or wicker weave (if applicable) are warranted against separation and tearing for one year from purchase date. Fading and/or discoloration resulting from exposure to the elements, oils, spills, fluids, chemicals, or any other cause is not covered.
- **Umbrellas.** Umbrellas (if applicable) are warranted against defects in material and workmanship only for one year from purchase date. Umbrella bases (if applicable) are not covered under any circumstance.
- **Table tops.** Natural stone tabletops only are warranted against defects in materials or workmanship only for one year from purchase date. All other table tops (including without limitation glass and faux stone) are not covered under any circumstances.

Warranty limitations: This warranty is subject to the limitations set forth above. In addition, this warranty is made to the original purchaser only, and is effective only when item(s) is purchased from one of our authorized dealers. This warranty is not transferable. For warranty replacements based on warranty claims submitted within the first year of purchase, we will pay shipping and handling charges within the continental North America. After the first year, shipping and handling charges are your responsibility. We will not be responsible for charges associated with shipments outside the continental North America at any time or for any reason.

Warranty exclusions: This warranty is subject to the exclusions as set forth above. In addition, the following are excluded from coverage under this warranty: any item used for commercial, contract or any other non-residential purpose; clearance items, display models or items purchased "as is"; freight damage; items subject to misuse, abuse, neglect or lack of proper care and maintenance (including without limitation as provided in any "care and maintenance guide"); normal wear and tear; damage caused by acts of nature, acts of force majeure, vandalism, fire or other casualty, or improper assembly; hardware against corrosion or rusting; purchased or replacement parts; and all plastic parts. Also excluded are loss of use or time; inconvenience; money; travel; packaging; or incidental, special or consequential damages of any kind. Replacement of defective items as provided herein shall constitute your sole and exclusive remedy for items which are not as warranted. In no event shall our responsibility exceed the purchase price of the items found to be other than as warranted. This warranty is the exclusive statement of your rights with respect to the defects in the items you have purchased and supersedes any other express warranty or statement, written or oral, made in connection with the purchase and sale of such items. When used herein, the term "item" when used in the singular, refers to the specific item found to be defective, and not to the entire set of which the item is a part.

Some states do not allow exclusion or limitation of incidental or consequential damages, so that limitation above may not apply to you. This warranty gives you specific legal rights, and you may also have other rights which vary from state to state.

ACOV018



AGIO INTERNATIONAL COMPANY LTD.

SHUNDE SHIAN FURNITURE INDUSTRIES CO. LTD.

PATIO FURNITURE & ACCESSORIES ASSEMBLY INSTRUCTIONS

IMPORTANT!!!

STOP! PLEASE READ THESE INSTRUCTIONS CAREFULLY BEFORE ASSEMBLY. MAKE SURE YOU HAVE ALL THE PARTS AND HARDWARE AS IDENTIFIED ON THE PARTS LIST.

MISSING PARTS? DAMAGED PARTS? DON'T GO BACK TO THE RETAILER. WE CAN HELP YOU FASTER!

CALL OUR CUSTOMER SERVICE CENTER AT 1-800-416-3511 BETWEEN 9:00AM AND 5:00PM (EASTERN TIME) MONDAY THROUGH FRIDAY (CLOSED HOLIDAYS).

OR, VISIT OUR WEBSITE AT: www.shianco.com

TO EXPEDITE ANY FUTURE WARRANTY CLAIMS, RETAIN THE INSTRUCTION SHEET, WARRANTY CARD AND RECEIPT FOR FUTURE USE. YOU ARE ENCOURAGED TO REGISTER YOUR PURCHASE ON OUR WEBSITE AT www.shianco.com

FOR ADDITIONAL ONLINE VIDEO SUPPORT ON ASSEMBLY, TROUBLESHOOTING, AND CARE AND MAINTENANCE OF YOUR OUTDOOR FURNITURE, PLEASE VISIT OUR WEBSITE AT: www.shianco.com/support

**IMPORTANT!! PLEASE READ ENTIRE INSTRUCTION SHEET BEFORE ASSEMBLY!!
TO EXPEDITE ANY FUTURE WARRANTY CLAIMS, PLEASE KEEP INSTRUCTION SHEET, WARRANTY CARD AND RECEIPT**

Step 1: Remove all protective materials and set parts on a flat, non-abrasive surface. Identify parts packed in carton against the parts list. If you are missing any parts or are unsure how to proceed with assembly, call our Customer Service Center at 1-800-416-3511. **Do not attempt assembly if any parts are missing or damaged.**

Step 2: Place the table top upside down on a flat, non-abrasive surface. Attach table leg to table top using a 1/4"x20 mm bolt and washer as shown in diagram. Guide bolt through hole in table leg, into pre-drilled hole in the table top. Hand tighten three to four turns only. **Do not tighten completely.** Some adjustments may be necessary to ensure proper alignment of the table legs. Repeat for other three legs.

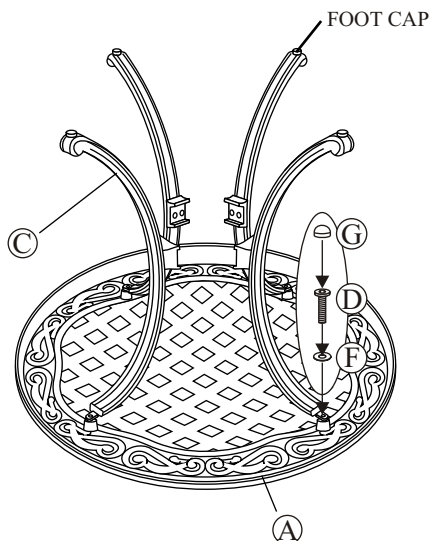

Step 3: Build the leg assembly. Attach the legs to the leg connector bracket using the 1/4"x28 mm bolts. Add a washer to each bolt. Guide these bolts through the holes in the leg connector bracket, and then into the fixed nuts already in place in the legs. **Do not tighten too much, only three to four turns to ensure the leg stays in position.** Repeat this procedure on the other three legs.

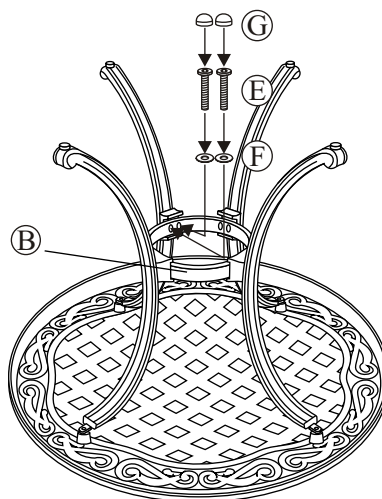











Step 4: After making any necessary adjustments to the alignment of the table legs and the leg connector bracket, use the hex bolt driver to tighten all bolts. **Note:** each bolt must be tightened a few revolutions at a time. In order to apply equal pressure to all bolt joints, we recommend working in a cross corner (X fashion). Repeat until all bolts are tight. **Do not over tighten.** Over tightening may strip bolts. Cover all bolts with covers.

Step 5: With the help of another person, turn the table in the upright position. If you have any questions, please call our Customer Service Center at 1-800-416-3511.

IMPORTANT NOTE: Damage to welds or frames resulting from over tightened bolts or improper assembly is not covered under our warranty. Please read all instructions carefully before assembly. If you have any questions regarding your assembly, call our Customer Service Center at 1-800-416-3511.

** NOTE: PARTS SHOWN ON PARTS LIST ARE NOT TO SCALE*

	PARTS LIST	DESCRIPTION	ORDER PART #	QTY
A		TABLE TOP		1
B		LEG CONNECTOR BRACKET		1
C		TABLE LEG		4
D		1/4" X 18 MM BOLT	HW0035	4
E		1/4" X 28 MM BOLT	HW0084	8
F		Ø6.5 X 1.0 MM WASHER	HW0004	12
G		BOLT COVER	HW0105	12
H		HEX BOLT DRIVER	HW0006	1
I		TOUCH-UP PAINT	G0003	1
		FOOT CAP FACTORY ASSEMBLY	FC0069	

ALF41715

CARE AND MAINTENANCE

FRAMES

Cleaning - Use mild soap and warm water. Do not use abrasive materials, cleansers or bleach products. Rinse with clean water and dry thoroughly.

Maintenance - Periodically clean and dry thoroughly. Be sure to drain any water accumulated inside the frames. To thoroughly drain frames, remove foot caps and tilt the frames, if necessary, to remove all water. This is critical. Water allowed to accumulate inside the frames and then exposed to sub-freezing temperatures can cause damage to the frame tubing. Such damage is not covered under warranty. Always clean, drain and dry thoroughly before storing for the winter. For best results, always store or cover your furniture when not in use. We recommend commercially available outdoor furniture covers. Any small nicks or scratches can be covered with a light application of touch-up paint.

** When cleaning or moving large or heavy items, always have two people work together. Never drag furniture.

LIMITED WARRANTY

- **Frames.** Frame construction is warranted against defects in material and workmanship for seven years from purchase date. Damage to frames or welds resulting from improper assembly or exposure to water and/or sub-freezing temperatures is not covered.
- **Finishes.** Paint finishes are warranted against peeling, cracking and blistering for one year from purchase date provided the unit has not been scratched or abraded. Chips and scratches resulting from normal wear and tear are not covered.
- **Fabrics.** Fabric and cushions (if applicable) are warranted against separation at the seams for one year from purchase date. Fading and/or discoloration resulting from exposure to the elements, oils, spills, fluids, chemicals, or any other cause is not covered.
- **Straps and/or wicker.** Straps and/or wicker weave (if applicable) are warranted against separation and tearing for one year from purchase date. Fading and/or discoloration resulting from exposure to the elements, oils, spills, fluids, chemicals, or any other cause is not covered.
- **Umbrellas.** Umbrellas (if applicable) are warranted against defects in material and workmanship only for one year from purchase date. Umbrella bases (if applicable) are not covered under any circumstance.
- **Table tops.** Natural stone tabletops only are warranted against defects in materials or workmanship only for one year from purchase date. All other table tops (including without limitation glass and faux stone) are not covered under any circumstances.

Warranty limitations: This warranty is subject to the limitations set forth above. In addition, this warranty is made to the original purchaser only, and is effective only when item(s) is purchased from one of our authorized dealers. This warranty is not transferable. For warranty replacements based on warranty claims submitted within the first year of purchase, we will pay shipping and handling charges within the continental North America. After the first year, shipping and handling charges are your responsibility. We will not be responsible for charges associated with shipments outside the continental North America at any time or for any reason.

Warranty exclusions: This warranty is subject to the exclusions as set forth above. In addition, the following are excluded from coverage under this warranty: any item used for commercial, contract or any other non-residential purpose; clearance items, display models or items purchased "as is"; freight damage; items subject to misuse, abuse, neglect or lack of proper care and maintenance (including without limitation as provided in any "care and maintenance guide"); normal wear and tear; damage caused by acts of nature, acts of force majeure, vandalism, fire or other casualty, or improper assembly; hardware against corrosion or rusting; purchased or replacement parts; and all plastic parts. Also excluded are loss of use or time; inconvenience; money; travel; packaging; or incidental, special or consequential damages of any kind. Replacement of defective items as provided herein shall constitute your sole and exclusive remedy for items which are not as warranted. In no event shall our responsibility exceed the purchase price of the items found to be other than as warranted. This warranty is the exclusive statement of your rights with respect to the defects in the items you have purchased and supersedes any other express warranty or statement, written or oral, made in connection with the purchase and sale of such items. When used herein, the term "item" when used in the singular, refers to the specific item found to be defective, and not to the entire set of which the item is a part.

Some states do not allow exclusion or limitation of incidental or consequential damages, so that limitation above may not apply to you. This warranty gives you specific legal rights, and you may also have other rights which vary from state to state.



AGIO INTERNATIONAL COMPANY LTD.

SHUNDE SHIAN FURNITURE INDUSTRIES CO. LTD.

PATIO FURNITURE & ACCESSORIES ASSEMBLY INSTRUCTIONS

IMPORTANT!!!

STOP! PLEASE READ THESE INSTRUCTIONS CAREFULLY BEFORE ASSEMBLY. MAKE SURE YOU HAVE ALL THE PARTS AND HARDWARE AS IDENTIFIED ON THE PARTS LIST.

MISSING PARTS? DAMAGED PARTS? DON'T GO BACK TO THE RETAILER. WE CAN HELP YOU FASTER!

CALL OUR CUSTOMER SERVICE CENTER AT 1-800-416-3511 BETWEEN 9:00AM AND 5:00PM (EASTERN TIME) MONDAY THROUGH FRIDAY (CLOSED HOLIDAYS).

OR, VISIT OUR WEBSITE AT: www.shianco.com

TO EXPEDITE ANY FUTURE WARRANTY CLAIMS, RETAIN THE INSTRUCTION SHEET, WARRANTY CARD AND RECEIPT FOR FUTURE USE. YOU ARE ENCOURAGED TO REGISTER YOUR PURCHASE ON OUR WEBSITE AT www.shianco.com

FOR ADDITIONAL ONLINE VIDEO SUPPORT ON ASSEMBLY, TROUBLESHOOTING, AND CARE AND MAINTENANCE OF YOUR OUTDOOR FURNITURE, PLEASE VISIT OUR WEBSITE AT: www.shianco.com/support